

# SIS Short Path Thermal Desorption System Model TD5 User Manual

Scientific Instrument Services, Inc.  
1027 Old York Rd. Ringoes, NJ 08551  
(908) 788-5550  
<http://www.sisweb.com/sptd>

Publication No. 785000M  
Document Revision 5.0.1 (February 2006)

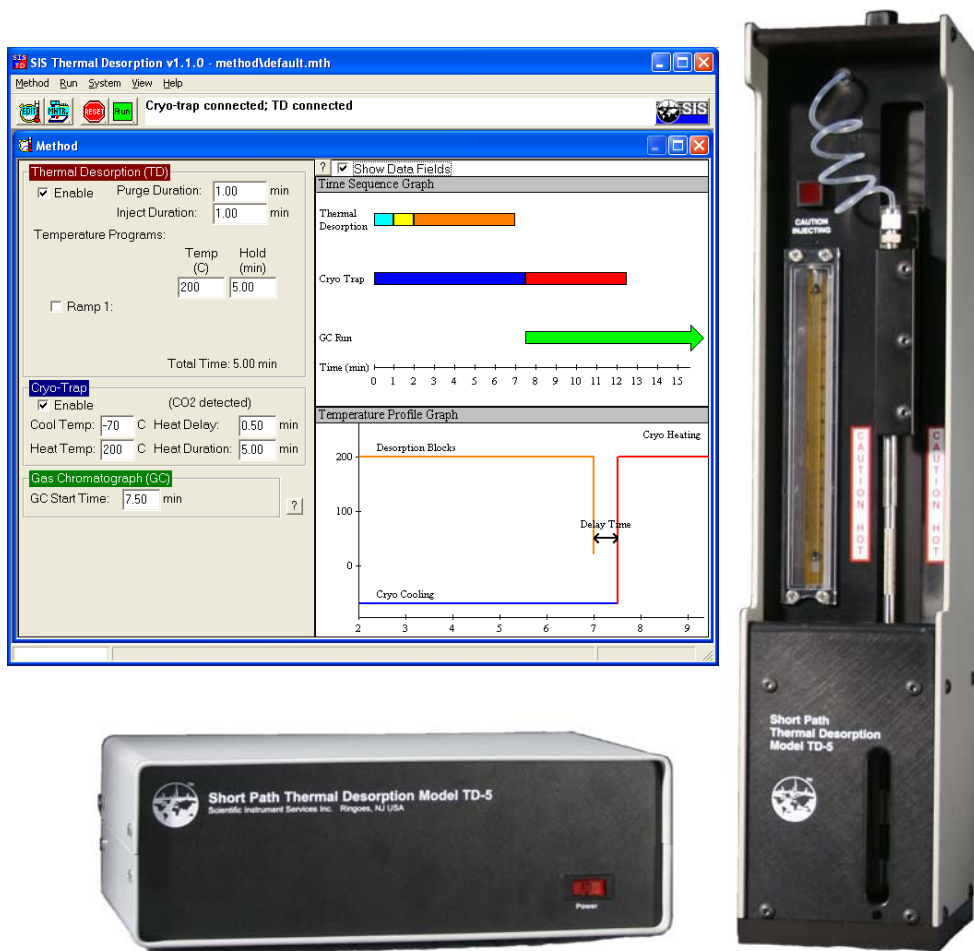

A versatile technique for the analysis of volatile and semi-volatile organics in solid, liquid and gas samples.

## **NOTICE**

The information contained in this document is subject to change without notice.

Scientific Instrument Services (S.I.S.) makes no warranty of any kind with regard to the material contained in this manual, including, but not limited to, the implied warranties of merchantability and fitness of the equipment and techniques therein described for a particular purpose.

S.I.S. shall not be liable for errors contained herein or for incidental or consequential damages in connection with the furnishing, operation, performance or use of the TD-5 Short Path Thermal Desorption System described in this manual.

S.I.S. assumes no responsibility for the use or reliability of its equipment that is not furnished by S.I.S.

This document contains proprietary information which is protected by copyright and patents. All rights are reserved. No part of this document may be photocopied, reproduced or translated to another language without the prior written consent of Scientific Instrument Services, Inc.

Patents covering the design, operation, techniques, and unique features of the TD-5 Short Path Thermal Desorption System are pending.

U.S. Patent #5,065,614

U.S. Patent #5,123,276

U.K. Patent #GB 2 253 161 B

U.S. Patent #5,596,876.

Copyright (c) 1999-2005 Scientific Instrument Services

## ***About the Manual***

This manual covers the theory, installation, and operation of the Scientific Instrument Services, Inc. (SIS) Short Path Thermal Desorption (SPTD) System Model TD-5

The information in this manual is provided with the assumption that the user is familiar with general gas chromatography (GC) concepts and the operation of the instrument on which the TD-5 system is installed. Refer to the manuals supplied by the manufacturer of your GC for specifics on your GC and GC data system software.

Additional information can be found on the thermal desorption section of the SIS web site:

SIS Short Path Thermal Desorption Home Page

**<http://www.sisweb.com/sptd/>**

This includes product information, application notes, and adsorbent resins data.

## Table of Contents

NOTICE.....	1-2
About the Manual .....	1-3
Table of Contents.....	1-4
Table of Figures.....	1-7
Warranty, Service, and Repair.....	1-9
Safety Information .....	1-10
1. Introduction.....	1-11
Overview.....	1-12
Overview of System Components .....	1-14
Additional Information .....	1-17
TD-5 Short Path Thermal Desorption System Features .....	1-17
2. Hardware Installation.....	2-2
Overview.....	2-3
Site Preparation.....	2-3
Space Requirements.....	2-3
Line Voltage & Current .....	2-3
Gas Considerations - Desorbing Gas .....	2-3
Compressed Air for Solenoids.....	2-4
Cryo-Cooling .....	2-4
Installation on the Agilent 6890 GC.....	2-5
Unpacking.....	2-5
Gas Considerations - Desorbing Gas .....	2-7
Installation of Tee into Carrier Gas Line .....	2-7
GC Carrier Gas Solenoid Valve Installation.....	2-7
Installation of the Electronics Console .....	2-11
Hookup to PC.....	2-12
Cryo-Trap Installation.....	2-13
Installation on other top loading GCs .....	2-17
Next Steps.....	2-17
3. Software Installation.....	3-1
Overview.....	3-2
Installation .....	3-2
Configuration .....	3-7
ChemStation Integration.....	3-8
Reinstalling or Upgrading ChemStation.....	3-8
Starting the Thermal Desorption Software .....	3-8
4. Desorption Unit Description.....	4-1
Overview.....	4-2
Description of Desorption Unit.....	4-2
Auto-injector Description .....	4-5
Heater (Desorption) Block Operation.....	4-6
Carrier Gas Flow & Regulation.....	4-7
Rotameter.....	4-7
Carrier/Purge Pressure Gauge.....	4-9

Flexible Connecting Line.....	4-10
Connecting Tube.....	4-10
Air Pressure Switch .....	4-11
Warning Indicators .....	4-11
5. Desorption Tubes .....	5-1
Overview.....	5-2
Needles for Desorption Tubes .....	5-2
Cleaning of Desorption Tubes .....	5-3
Packing Desorption Tubes.....	5-3
Conditioning Thermal Desorption Tubes .....	5-3
Desorption Tube Conditioning Oven.....	5-4
6. Software Operation .....	6-1
Overview.....	6-2
Getting Started .....	6-2
System Startup .....	6-2
Thermal Desorption Methods .....	6-2
Method Edit View.....	6-3
Saving settings .....	6-6
Importing settings .....	6-7
Running a Single Sample.....	6-7
Status Window .....	6-7
The Sample Log Book .....	6-8
Online Help.....	6-9
7. Standard Operating Parameters.....	7-1
Overview.....	7-2
GC Carrier Flow .....	7-2
GC Requirements.....	7-2
Splitless Operation with the Agilent (HP) 5890 Split/Splitless Injection System.....	7-4
Split Operation with the Agilent (HP) 6890/5890 Series GC's.....	7-4
Split or Splitless Mode Operation with the Varian 3800 GC with Split/Splitless Injector .....	7-5
Direct Thermal Extraction .....	7-5
Suggested Standard SPLIT/SPLITLESS INJECTION Protocol .....	7-6
Thermal Desorption and Sample Analysis .....	7-6
Special Methods.....	7-7
8. Troubleshooting .....	8-1
Overview.....	8-2
A. Flow and Mechanical System Problems .....	8-2
B. Electrical System.....	8-9
9. Desorption Tube Conditioning System.....	9-1
I. Introduction .....	9-2
A. Theory of Operation.....	9-2
B. Safety - Warning Messages.....	9-3
B. Specifications .....	9-4
C. Warranty & Service.....	9-5
II. System Description .....	9-8

A. Front Panel Description (Figure 9-1) .....	9-8
B. Rear Panel Description (Figure 9-3) .....	9-9
III. Gas Flow Circuit .....	9-10
IV. Heater Circuit .....	9-11
A. Heater Protection Circuitry .....	9-11
B. Watlow Temperature Controller .....	9-12
Description of the Keys and Display .....	9-13
Temperature Controller System SETUP .....	9-13
Setting up the Temperature Program for the Watlow Controller.....	9-15
V. Standard Procedures for Preparing and Conditioning Desorption Tubes.....	9-17
10. Sample Oven.....	10-1
I. Introduction .....	10-2
Theory of Operation.....	10-2
Safety - Warning Messages .....	10-3
Specifications.....	10-3
Warranty .....	10-4
II. System Description .....	10-6
Front Panel Description (Figure 10-1).....	10-6
Electrical and Gas Flow Circuit.....	10-7
Heater Circuit.....	10-8
Heater Protection Circuitry .....	10-10
Temperature Controller System SETUP .....	10-11
Operation of the Sample Oven System.....	10-12
I. Turn on Procedure .....	10-13
II. Cleaning & Conditioning Sample Tubes .....	10-13
III. Sampling .....	10-14
Appendix A – TD Specifications.....	10-1

## Table of Figures

Figure 1-1 – Diagram of desorption (sample) tube, Desorption Unit, and Gas Chromatograph (GC).	1-11
Figure 1-2 - Injection and desorption of sample tube in the desorption unit.	1-13
Figure 1-3 – SIS Purge & Trap device for adsorbing sample onto desorption tube packed with adsorbent.	1-14
Figure 1-5 – Electronics Console (front and back)	1-15
Figure 1-7 – Thermal Desorption Software	1-16
Figure 1-8 – SIS TD-5 system installed on a GC (Agilent 6890 GC shown here).	1-18
Figure 2-1 – Example installation kit.	2-2
Figure 2-2 – SIS TD-5 system with items included in the TD-5 installation kit (#785231) for the Agilent 6890.	2-5
Figure 2-3 – (a) Install tee at back of GC; (b) Tee installed allowing carrier gas hookup to TD-5 system.	2-7
Figure 2-4 – (a) View of left side of GC with side cover removed; (b) valve assembly installed.	2-8
Figure 2-5 – (a) Cutting GC carrier line; (b) Plumbing for valve assembly; (c) Route tubing from valve assembly to exit port	2-8
Figure 2-6 – Attaching mounting plate to Desorption Unit.	2-9
Figure 2-7 – Schematic showing the location of the gas inlets on the rear of the Desorption Unit.	2-10
Figure 2-8 – (a) 1/8” Teflon™ tubing is used for the carrier gas line and the compressed air line on the Desorption Unit; (b) Installation fo the interconnect cable (#782010).	2-10
Figure 2-9 – TD-5 Desorption Unit installed on the Agilent 6890 injection port. Electronics Console is shown to its side (but may be placed elsewhere).	2-11
Figure 2-10 – Rear view of the Electronics Console.	2-12
Figure 2-11 – Remove insulation cup from inlet.	2-13
Figure 2-12 – Run wires through hole in side of the GC (note: LN2 lines also exit the side of the GC oven).	2-14
Figure 2-13 – Stop collar and clamp for cryo-trap	2-15
Figure 2-14 – Cryo-Trap installed.	2-16
Figure 2-15 – Tapped holes on bottom of Desorption Unit aid in installation.	2-17
Figure 3-1 – Welcome Page for installation of the Thermal Desorption Software.	3-1
Figure 3-2 – Online documentation	3-3
Figure 3-3 – Installation program, selection of installation location.	3-4
Figure 3-4 – Installation program, confirmation page	3-5
Figure 3-5 – Installation program, installing files	3-5
Figure 3-6 – Installation program, installation complete.	3-6
Figure 3-7 – Configure System window	3-7
Figure 3-8 – updating ChemStation macros	3-8
Figure 3-9 – Accessing the thermal desorption software from the Windows Start Menu.	3-9
Figure 4-1 – Components of TD-5 Desorption Unit	4-1
Figure 4-2 – Desorption Block Heating	4-3

Figure 4-3 - Desorption Block Cooling .....	4-4
Figure 4-4 - Temperature Rise inside Desorption Tube - Effect of Carrier Flow on Temperature .....	4-4
Figure 4-5 - Flow Meter Calibration Data .....	4-9
Figure 4-6 - Properties of Various Materials Used in Sealing Washers .....	4-10
Figure 4-7- Accessories for Thermal Desorption System.....	4-12
Figure 5-1 – Photos and diagrams of desorption (sample) tubes.....	5-1
Figure 6-1 – Thermal Desorption Software window .....	6-1
Figure 6-2 – Thermal Desorption Method Window .....	6-3
Figure 6-3 - Setting the Inject Time Parameter .....	6-5
Figure 6-4 - Status Window .....	6-8
Figure 6-5 - Sample Log Book .....	6-8
Figure 7-1 – Purge and divert gas operation.....	7-9
Figure 8-1 – Example error message in the Thermal Desorption Software .....	8-1
Figure 8-2 – Configure System dialog box with Communications Port setting .....	8-11
Figure 9-1 – Desorption Tube Conditioning Oven – Front View.....	9-1
Figure 9-2 – Desorption Tube Conditioning Oven Theory of Operation.....	9-6
Figure 9-3 – Desorption Tube Conditioning Oven – Rear View.....	9-7
Figure 9-4 – Conditioning Oven Handles.....	9-8
Figure 9-5 – Desorption Tube Conditioning Oven Schematic .....	9-10
Figure 9-6 – Watlow temperature controller keypad/display .....	9-12
Figure 9-7 – Funnel with Desorption Tube.....	9-17
Figure 9-8 – Cross-section of packed GLT desorption tube.....	9-18
Figure 10-1 – Sample Collection Oven .....	10-1
Figure 10-2 - Sample Oven - Back View.....	10-8
Figure 10-3 - Sampling Oven Schematic.....	10-9
Figure 10-4 – Watlow Temperature Controller keys and display.....	10-10
Figure 10-5 - The factory preset values are listed above.....	10-12
Figure 10-6 – Cross section of Sample Collection Oven for the collection of thermally sparged samples. ....	10-13
Figure 10-7 – Sample tube with connectors .....	10-15
Figure 10-8 - Fittings & Adaptors for Sample Collection Oven .....	10-15
Figure 10-9 - Sample Collection Oven System and Accessories .....	10-16



## ***Warranty, Service, and Repair***

### **Warranty**

The Desorption Unit and Electronics Console are warranted against defects in material and workmanship for a period of one year commencing from the date of shipment from the warehouse of Scientific Instrument Services in Ringoes, NJ, hereafter referred to as the company. The company's liability on the TD-5 system and accessories is limited to the cost of correcting the defect in the product. In no case shall the company be liable for consequential or special damages. The company will not correct defects caused by the buyers negligence. The company does not guarantee or warrant the product for any particular purpose. The company's warranty shall end one year after shipment.

### **Extended Warranty**

An extended one year warranty for parts and labor is available if purchased within 12 months of shipment of the unit. The one year extended warranty will cover parts and labor to repair the Thermal Desorption Unit and Electronics Console within the facilities of Scientific Instrument Services. Service at customers' facilities is not available.

### **Service and Repair**

Any equipment to be serviced under warranty or otherwise should be sent to the repair facilities of Scientific Instrument Services in Ringoes, NJ. No on site service is available. A return authorization number (RA#) must be obtained from the offices of Scientific Instrument Services before any equipment is returned.

Scientific Instrument Services, Inc.  
1027 Old York Road  
Ringoes, NJ 08551  
Attn: Repair Department  
RA# \_\_\_\_\_  
Phone: (908) 788-5550

**KEEP ALL BOXES AND PACKAGING.** When returning systems for repair they should be sent in original system boxes and packaging. If we do not receive your original packaging, an extra fee will be charged for new packaging when we return the system to you.

## ***Safety Information***

WARNING **Power Ground** - The Thermal Desorption System must be connected to a power source equipped with a **protective earth ground**. Connection otherwise creates a shock hazard for the operator and can damage the instrument.

WARNING **110/220 V** – The TD-5 is normally shipped and set up for 100 Volt AC operation. It is also available in a 220 V version. Check the TD5 Electronics Console for voltage setting before use.

WARNING **Fuses** - Use only fuses with the required current rating and of the type specified for replacement. The use of incorrect or makeshift fuses or the short-circuiting of fuse holders creates a shock hazard for the operator and can damage the instrument.

WARNING **Maintenance** - Any adjustment, maintenance or repair of the opened instrument while it is connected to a power source should be avoided if possible and, if required, should be carried out only by trained persons who are aware of the hazards involved. **The instrument should be powered off and unplugged during maintenance.**

WARNING **High Temperatures** - Keep hands and fingers away from inside the desorption cabinet. The Desorption Unit contains high temperatures moving parts that will seriously burn hands or fingers. After samples have been heated and desorbed and the desorption tube is withdrawn from the injection port, the desorption tube and needle will remain hot until they are permitted to air cool to room temperature. It will usually take from 5 to 10 minutes until this assembly has cooled to where it is touchable. **In no case should this tube be touched or removed until it has cooled for a minimum of 5 minutes.**

WARNING **Maximum Times** - Do not leave Desorption unit heaters in the heated ON position unattended overnight. The Desorption unit heaters rapidly heat and cool to their final operating temperatures and therefore, in order to prolong their life, should be turned off when not actively being used to heat samples for analysis.

WARNING **Maximum Temperatures** - Do not desorb samples above **400° C**. Exceeding this temperature may damage thermal desorption blocks.

WARNING **Do NOT use HYDROGEN Gas** in the Desorption Unit. The rapid rise of gases to high temperatures does not permit the use of explosive gas mixtures.

WARNING **Compressed air** is required for the operation of the desorption unit. This pressure is normally set to **40-60 psi** and in NO case shall exceed 100 psi.

# 1. Introduction

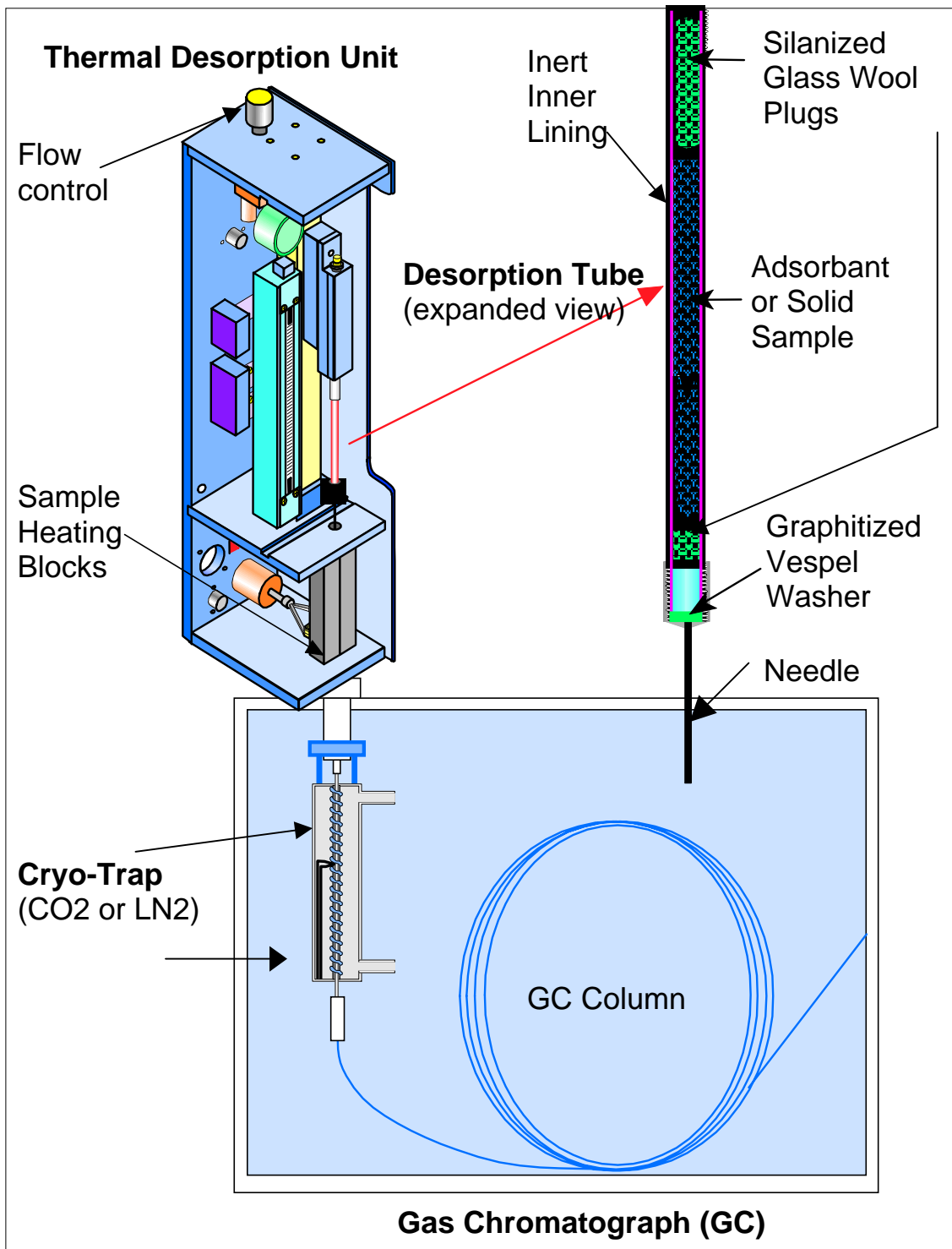
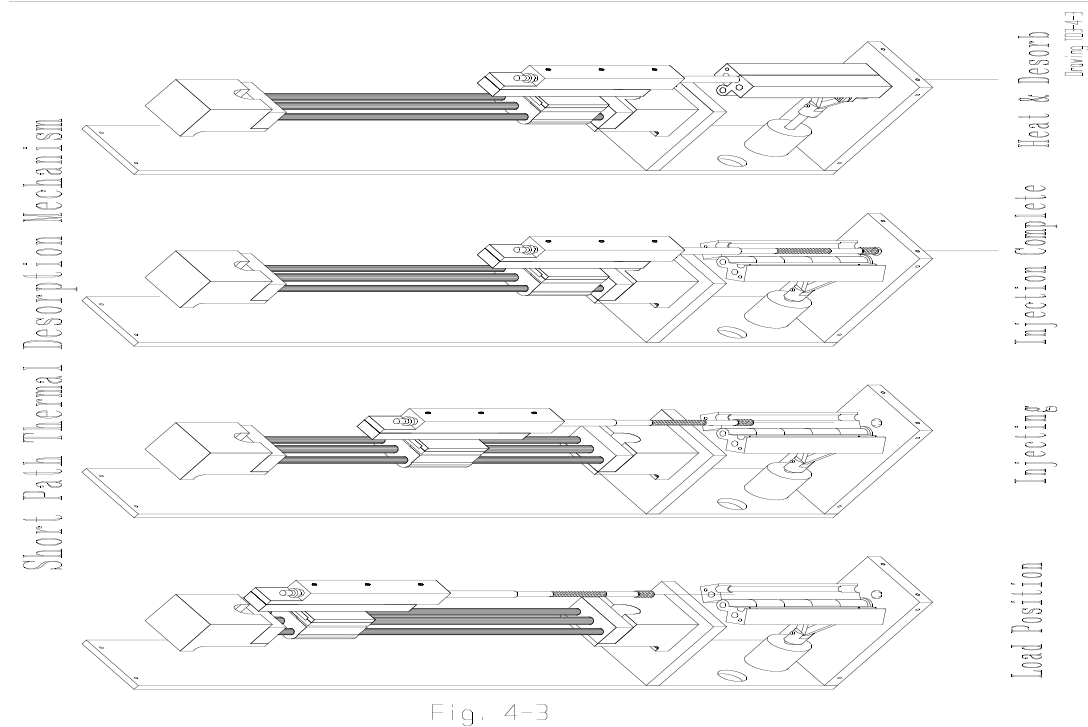

Figure 1-1 – Diagram of desorption (sample) tube, Desorption Unit, and Gas Chromatograph (GC).

## **Overview**

The Short Path Thermal Desorption (SPTD) technique has been developed for the thermal extraction of volatile and semi-volatile organic compounds (VOCs) into a gas chromatograph (GC). Volatile and semi-volatile organics in air, flavors and fragrances in foods and cosmetics, manufacturing chemical residues in pharmaceuticals, volatiles in packaging materials and building products, and aromatic residues in forensic arson samples are just a few of the applications to which this technique has been adapted.

This method involves the purging and trapping of VOCs onto a glass (GLT) or silco-coated stainless steel desorption tube packed with an adsorbent resin (e.g. Tenax™ TA or activated carbon). In an alternate method called Direct Thermal Extraction (DTE), a solid matrix sample is placed directly into the desorption tube. This tube is then fitted with a syringe needle and placed into the Desorption Unit (Figure 1-1). The desorption tube containing the sample is then injected into the GC injection port (much like a GC syringe) and heater blocks are closed around the tube to heat the sample and release analytes onto the GC column (Figure 1-2). The GC column (either capillary or packed) is normally maintained at sub-ambient temperatures, or at a suitable temperature low enough to retain any volatiles, during the initial desorbing (typically 5-15 minutes). Though this may be accomplished by cryogenically cooling the entire GC oven, it is more efficient to use the optional SIS Cryo-Trap to cryogenically cool (via CO<sub>2</sub> or LN<sub>2</sub>) and trap analytes at the head of the GC column. When the sample has been fully desorbed into the GC column, the Cryo-Trap rapidly heats to release the trapped analytes in a narrow band. The analytes travel through the GC column and into the detector (e.g. a mass spectrometer, MS). This entire process permits the “short path” desorption of samples into the GC injection port and column, providing for the optimum delivery of samples (maximum sensitivity) to the GC.



**Figure 1-2 - Injection and desorption of sample tube in the desorption unit.**

As mentioned there are two main thermal desorption techniques supported by the TD-5:

**Short Path Thermal Desorption** - The technique of Short Path Thermal Desorption (SPTD) is also commonly known as **Purge and Trap** Thermal Desorption (P&T-TD) and is widely used in US-EPA methodology including EPA methods 524 and 624 for water analysis. In this technique, volatiles and semi-volatiles are trapped on adsorbent resins inside the desorption tube and then are subsequently thermally desorbed into the GC. (Figure 1-3)

**Direct Thermal Extraction** - Direct Thermal Extraction (DTE) is an alternative method of analysis using the TD-5. This technique permits the analysis of low moisture content samples which have been placed directly in the desorption tubes. Samples such as spices, paint chips, pine needles and fibers can be analyzed using this technique. Water vapor must be minimized since it will condense at the front of the GC column (if kept at sub-ambient temperatures) and possibly plug the GC capillary column.

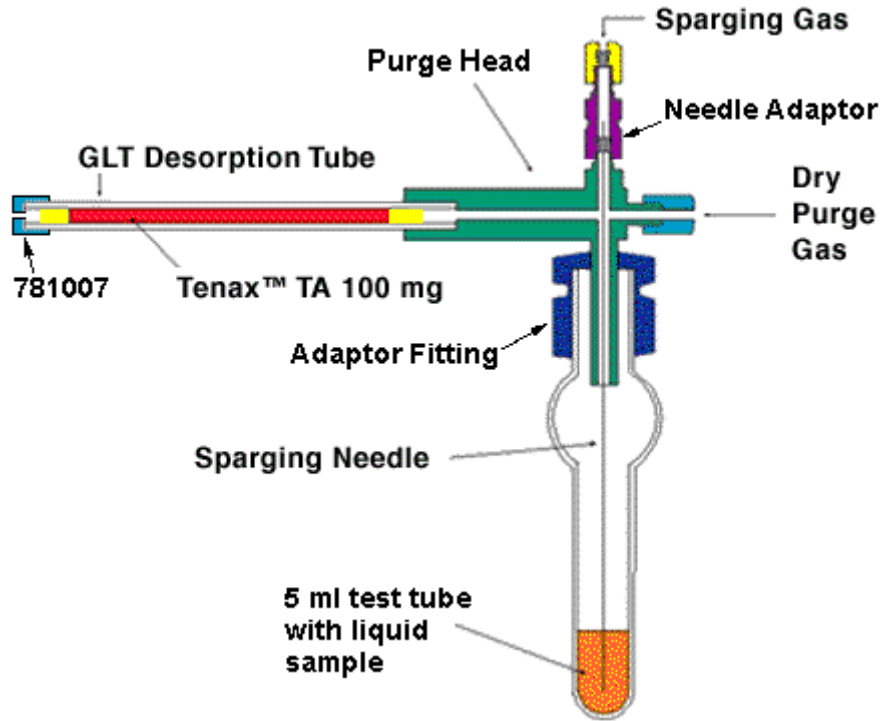

Figure 1-3 – SIS Purge & Trap device for adsorbing sample onto desorption tube packed with adsorbent.

### Overview of System Components

The SIS TD-5 Short Path Thermal Desorption System consists of four modules: a **Desorption Unit**, a microprocessor controlled **Electronics Console**, a **Cryo-Trap**, and **Thermal Desorption Software** on the PC.

**The Desorption Unit** (Figure 1-4) is placed directly on top of the injection port of most GC's, where it is used for the direct desorption of samples into the GC injection port and column. The septum nut on the GC slips into a groove in the bottom plate of the Desorption Unit to correctly align the system for injection. No mounting hardware, screws or bolts are required to install the Desorption Unit. On some systems it may be necessary to add an accessory plate around the injection port to provide a stable base on which the Desorption Unit can sit. The septum nut groove and the weight of the unit hold the Desorption Unit in place during injection and analysis of samples. The Desorption Unit can be easily lifted off the injection port of the GC for conventional injection of samples by syringe or autosamplers, and can then be easily slipped back onto the injection port nut for desorbing samples into the injection system.

**The Electronics Console** (Figure 1-5) contains the power supply, microprocessor, I/O, and temperature control logic. The Electronics



Figure 1-4 - Desorption Unit

## 1 - Introduction

Console connects to the Desorption Unit by a single electronics cable. The Electronics Console is also connected to Thermal Desorption Software on the PC via an RS-232 serial communications cable (USB $\leftrightarrow$ RS232 converter cable available also for connection to a USB port on the PC).



**Figure 1-5 – Electronics Console (front and back)**

**The Cryo-Trap** (Figure 1-6) cryogenically traps volatiles during the desorb process and then rapidly heats to release those volatiles in a narrow band. This is an optional but recommended accessory to the TD-5. The SIS Cryo-Trap will produce optimum results with a minimal use of cooling gas. The Cryo-Trap can be used with either Liquid Nitrogen (LN2) having a -180 °C minimum cooling temperature or liquid carbon dioxide (CO2) having a -70 °C minimum cooling temperature) depending on the cryo valve that was purchased with the system.

GC cryo-cooling capabilities using liquid nitrogen or carbon dioxide are recommended. Normally samples are desorbed from the desorption tube and trapped on the front of the GC column. In some cases these volatiles can be trapped on thick film megabore columns such as the J&W DB-624 column. However for microbore capillary columns and thin film columns it is preferable to cool the column below 0°C in order to trap the volatiles. Cryo-cooling is available on most gas chromatographs. Usually this accessory is ordered when the GC is first purchased, however most gas chromatographs can be upgraded to include cryo-cooling.

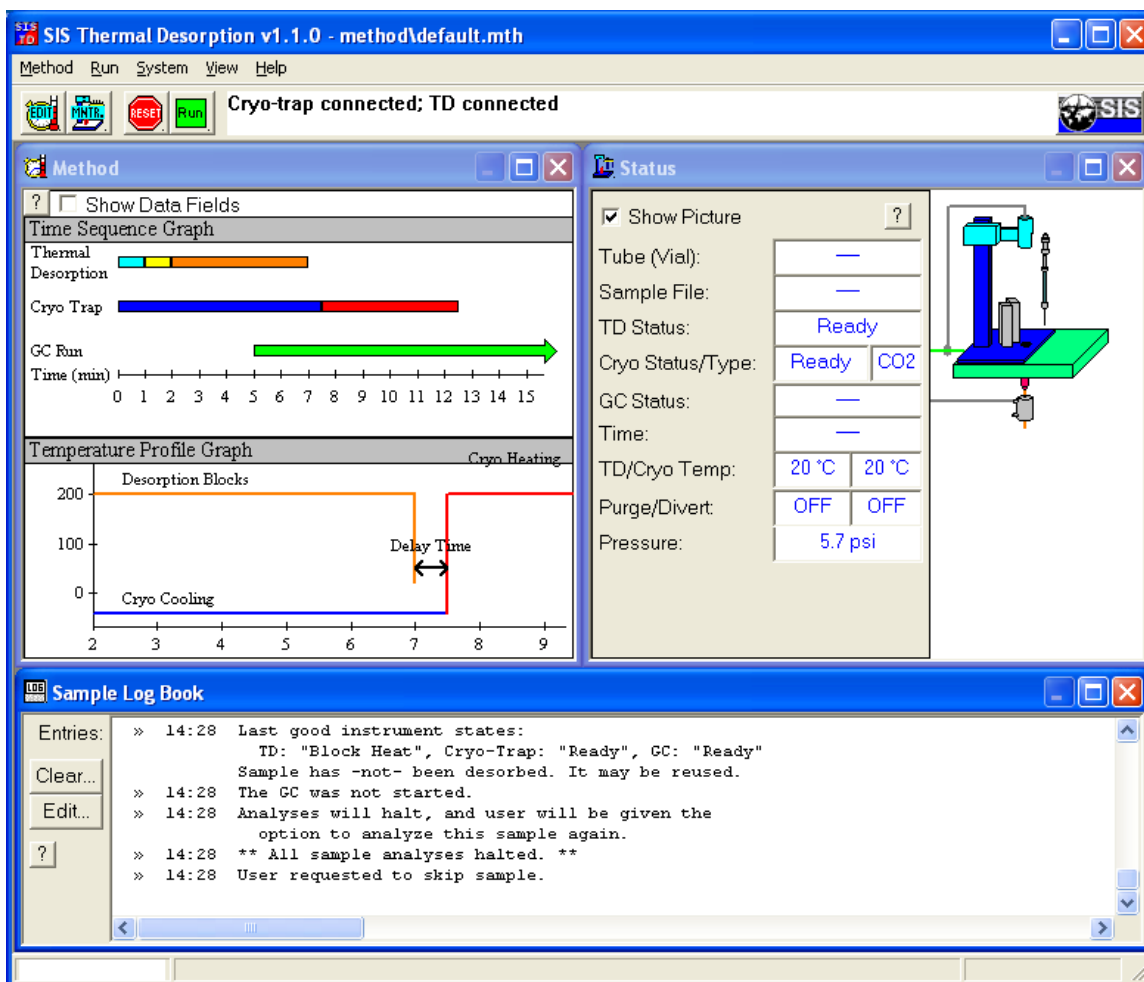

**Figure 1-6 - SIS 2'' Cryo-Trap**

**Thermal Desorption Software** – The thermal desorption software provides a graphical user interface (GUI) from which the operator can configure the thermal desorption system settings/run parameters, control the thermal desorption system (e.g. start runs), and monitor the thermal desorption system (e.g. temperatures and pressures). The thermal desorption software resides on a computer that is connected to the Electronics Console via an RS-232 serial communication cable (with optional RS232  $\leftrightarrow$  USB

## 1 - Introduction

converter cable). Typically, this computer is the same computer on which resides the software that controls the GC (the **GC data system software**).



**Figure 1-7 – Thermal Desorption Software**

The TD-5 can be operated in either of two modes: *standalone mode* (independent of the GC data system software) and *integrated mode* (integrated with the GC data system software). Which you use will depend on whether the thermal desorption software is able to integrate with your particular type of GC data system software. Currently, the integrated mode only works on version of Agilent (HP) ChemStation. (Check the online documentation for specific compatibility requirements or call SIS.) The standalone mode can work with any GC that the thermal desorption system is physically compatible with. The advantage of the integrated mode is that thermal desorption run settings are stored within (linked to) the GC method, and the run operation is a bit more coordinated (e.g. the thermal desorption system will start automatically when a new sample run is invoked from the GC data system).



## ***Additional Information***

The four components of the TD-5 are described in more detail in subsequent chapters.

### ***TD-5 Short Path Thermal Desorption System Features***

Some of the main features of the TD-5 system include

- High sensitivity thermal desorption and direct thermal extraction system
- Short path from sample tube to GC injection port
- Mounts ovetop GC injection port, easy installation
- Eliminate tedious sample cleanup by other techniques such as solvent extraction
- No memory effects-individual flow path for each sample preventing contamination of transfer lines
- Compact and portable-easily removable and transferable
- Usable with a wide variety of techniques on capillary and packed GC columns, including direct injection and split/splitless.
- Automatic injection of sample into GC.
- Desorb samples at temperatures from 20 to 400°C either isothermal or temperature program ramp at rates up to 100°/min.
- Rapid heating of samples at rates up to 200°/min.
- User programmable gas purge, injection, desorption and GC delay start times.
- Usable for qualitative and quantitative analysis of samples
- Glass lined stainless steel (GLT) and silco-coated sample tubes are both inert to samples and strong for sample handling and transporting
- Thermal desorption software on the PC allows setting method parameters, initiating runs, and monitoring temperatures/pressures. Optionally integrated into Agilent ChemStation.
- Programmable desorption time from 1 second to 100 minutes
- Automatic programming and control of Cryo-Trap accessory.
- GC remote start feature

## 1 - Introduction



**Figure 1-8 – SIS TD-5 system installed on a GC (Agilent 6890 GC shown here).**

## 2. Hardware Installation

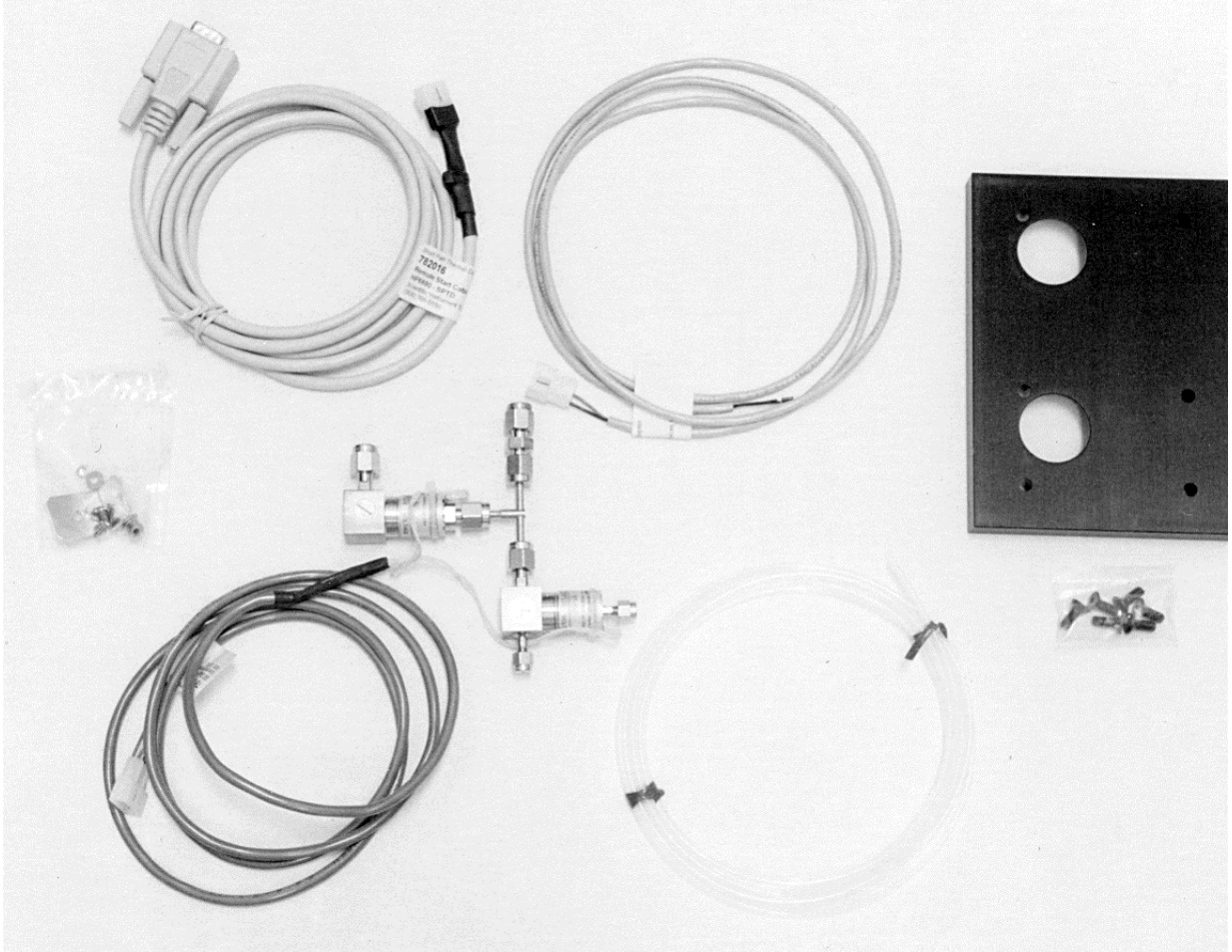

Figure 2-1 – Example installation kit.

### **Overview**

This section describes the installation of the TD-5 hardware. It includes details on installing on the Agilent HP 6890 GC and some general notes for other GCs. (Contact SIS for details on installing on other GCs.)

### **Site Preparation**

#### **Space Requirements**

The TD-5 is a compact, self contained injection system and desorption system that requires a minimum amount of space. The system is designed only for top injecting GC systems. The Desorption Unit sits directly over the injection port of the gas chromatograph.

The Electronics Console normally can sit on top of the GC oven cabinet providing it does not interfere with the operation of the GC. Alternatively, the Electronics Console can be placed on the lab bench next to the GC or on any other suitable shelf or supporting medium within 4' of the GC injection port.

See the Specifications section of the Appendix for dimensions and weights of the components.

#### **Line Voltage & Current**

The TD-5 requires a single 115 volt, 10 amp, 60 Hz, grounded outlet. The system is fuse protected with a main power fuse and a second fuse for the cartridge heater circuit. In no case should a fuse larger than the size recommended in this manual be used.

Power requirements are 115 Volts +/- 10% AC and 10 amp max.

#### **Gas Considerations - Desorbing Gas**

Standard GC carrier gas is used as the desorbing gas for the TD-5. High purity gases such as nitrogen or helium are recommended. The carrier gas should have a purity of at least 99.995% and must be delivered at 40-60 psi.

The same carrier gas used for the capillary or packed column carrier gas should be used as the desorbing gas in the TD-5 to avoid mixing gases in the GC injection port; which could cause an unstable baseline, especially with FID detectors. Due to the high temperatures and rapid heating of the components in the desorption system, the use of hydrogen could create an explosive condition.

**CAUTION - DO NOT USE HYDROGEN GAS IN THE DESORPTION SYSTEM**

### **Compressed Air for Solenoids**

A supply of clean compressed air or nitrogen is required. Compressed air from laboratory supply or cylinder at 40 psi is required. The fitting required for installation to the TD-5 is a 1/8" Swagelok fitting.

### **Cryo-Cooling**

**Liquid Nitrogen.** Liquid Nitrogen should be supplied in a large dewar, and liquid coolant at low pressure (30 psi) is recommended for optimum performance of the Cryo-Trap. When ordering Liquid Nitrogen specify that it is for Liquid use at Low pressure.

For the installation of the Liquid Nitrogen Cryo Valve, 1/4" copper lines are used for all connections. The 1/4 inch lines should be connected from the Liquid Nitrogen Tank directly to the Cryo Valve. A Second 1/4" copper line will connect the Cryo Valve to the Cryo-Trap inside the GC oven. These connections should always be made with 1/4 inch Swagelok™ fittings. For optimum results the Liquid Nitrogen lines should be insulated and the gas source should be located as close as possible to Cryo valve system. In addition the Cryo valve should be located as close as possible to the GC injection port. By keeping all lines as short as possible and insulated as much as possible, cooling cycle times will be minimized and cryogen gas usage will be minimized. LN2 must be delivered as a liquid under low (<50 psi) pressure, and the line from the supply should be insulated 1/8" metal tubing. Special evacuated or insulated coolant lines work well.

**Liquid CO2.** Liquid CO2 should be supplied in an A size gas tank. When ordering be sure to specify that it is to deliver Liquid and make sure the tank has a DIP tube.

For installation of the CO2 Cryo-Trap, a 1/8" stainless steel line provides the cooling gas from the tank to the Cryo Valve. This line does not need to be insulated, but for optimum performance should be kept as short as possible. Cryogen supplies should be located within 6-7 meters of the Cryo-Trap for best results. CO2 should be delivered with 1/8" metal tubing, and must be in liquid form. Insulation is not necessary for liquid CO2 supply lines. Tanks should be ordered specifically with an eductor or "dip" tube. Connect the tank to the supply line with a CGA #320 fitting (US) and a 1/4" NPT (female) to 1/8" Swagelok (male) adapter. A Regulator is NOT used with a CO2 tank. The connection from the Cryo Valve to the Cryo-Trap is made with a 1.0 meter length of 1/16" stainless steel tubing with an I.D. of 0.040" for optimum performance. It is recommended that this line not be shortened or changed to achieve optimum performance of the Cryo Trap cooling.

## ***Installation on the Agilent 6890 GC***

### **Unpacking**

1. The following items should have been received with your shipment, and are required for installation of the SIS TD-5 on the Agilent (HP) 6890. Be sure you have all the items before proceeding. If any items were not received with your system, call SIS immediately. See Figure 2-2 and the parts list included with your installation kit to aid in determining that all items were received. Save all packaging material and boxes if future factory service is required.



**Figure 2-2 – SIS TD-5 system with items included in the TD-5 installation kit (#785231) for the Agilent 6890.**

## 2 - Hardware Installation - Installation on the Agilent 6890 GC

<b>Part #</b>	<b>Description</b>	<b>Qty.</b>
785000	TD5 Short Path Thermal Desorption System	
785000D	TD5 Desorption Unit	1
785000C	TD5 Electronics Console	1
785000M	TD5 Manual	1
780000	Thermal Desorption Software CD	1
782010	Interconnect Cable, 6 Ft.	1
783500	Power Cable for Electronics Console	1
785231	HP6890 Installation Kit	
CL424	Pliers	1
T125062	Teflon™ tubing, 1/8" OD x 10'	1
B2003	Tee	2
78225	Riser plate	1
786001	4 mm ID Silco tube	1
781006	SS solid caps for GLT tube	2
781016	Graphite needle seal	1
781018	Graphitized Vespel needle seal	1
786035	Needle assy., 35mm side hole	1
781106	Septum adaptor	1
78225	Mounting plate	1
785016	Remote cable for HP6890	1
7859993	GC gas valve assembly	1

2. The following are not included with the system but are required for installation.

- a. Tubing cutter for cutting 1/16" S.S. carrier gas line.
- b. 5/16" wrench to tighten 1/16" Swagelok fittings.
- c. 7/16" wrench to tighten 1/8" Swagelok fittings
- d. Snoop leak detection fluid.
- e. Approximately 18" of 1/8" flexible copper tubing.

**NOTE:** The TD-5 must be used on the front injection port of the GC if more than one injection port is present. If injection port is installed on rear position it will need to be moved to the front position.

While the TD-5 may be installed on various Agilent inlets, the split/splitless injection port is recommended.

**CAUTION: Be sure all power to the gas chromatograph is off and the GC is unplugged before proceeding.**

## **Gas Considerations - Desorbing Gas**

NOTE: The carrier gas for the desorption system can easily be plumbed in by adding a cross or tee into the carrier gas line before it enters the gas chromatograph. The instructions below describe how to do this.

The installation of a cross or tee in the carrier gas line requires a tubing cutter, a 7/16" wrench and a Swagelok™ brass cross (B-200-4) or brass tee (B-200-3).

3. Shut off carrier gas at the tank and vent the supply line to the GC.

### **Installation of Tee into Carrier Gas Line**

4. Figure 2-3a shows the use of a tubing cutter to cut the carrier gas line just before it enters the GC.

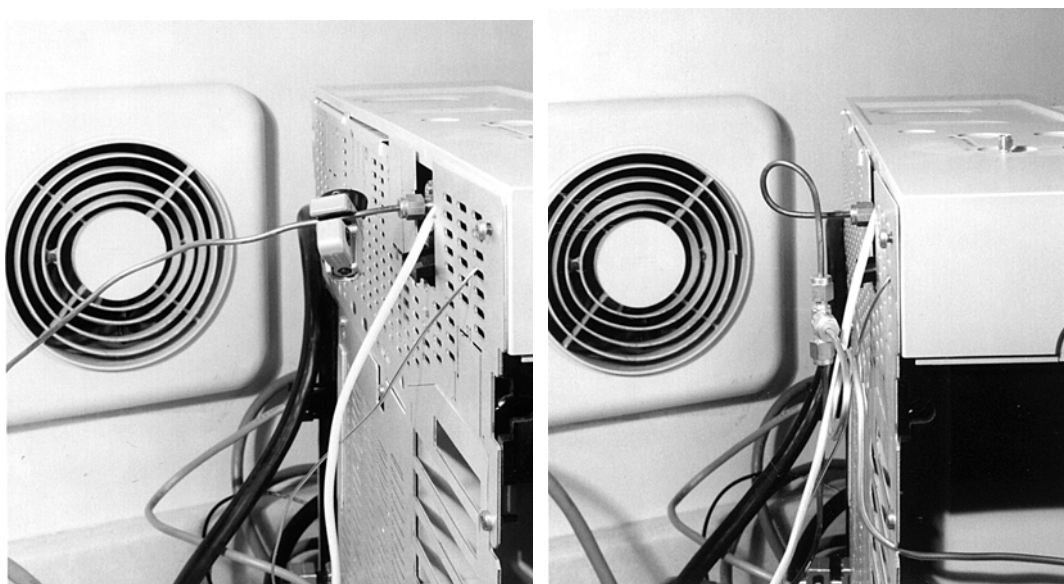

**Figure 2-3 – (a) Install tee at back of GC; (b) Tee installed allowing carrier gas hookup to TD-5 system.**

5. Install a 1/8" Swagelok™ Tee (from the TD-5 installation kit) as shown with the new 1/8" line coming around the side or top of the GC. See Figure 2-3b.

3. Be sure the tubing is completely seated in the fitting and tighten 3/4 turns past finger tight.

### **GC Carrier Gas Solenoid Valve Installation**

6. Remove the injection port cover plate and the left side cover plate of the gas chromatograph as shown in Figure 2-4a to gain access to the injection port. This will require movement of the MSD if installed.



## 2 - Hardware Installation - Installation on the Agilent 6890 GC

7. Install the carrier gas solenoid valve assembly (7859993) using the bracket enclosed with the valve assembly. This valve can be mounted on the left side of the GC with the bracket as shown in Figure 2-4.

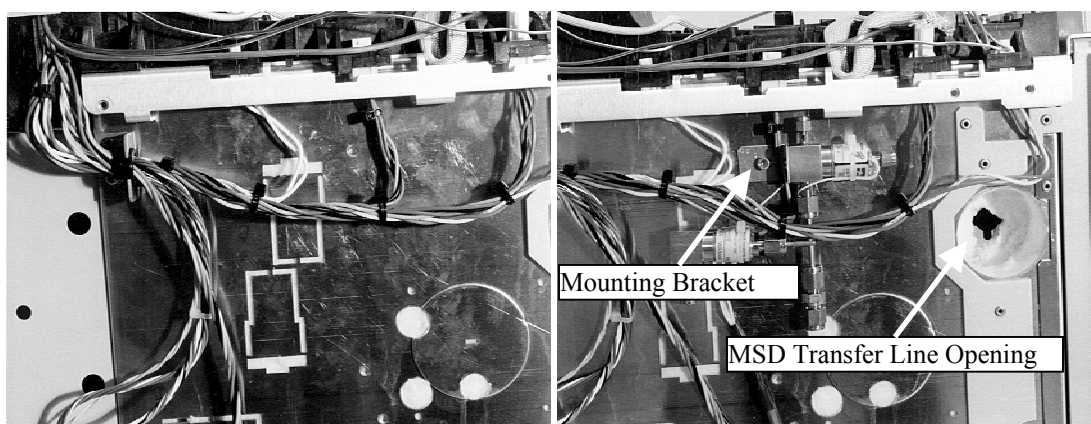

**Figure 2-4 – (a) View of left side of GC with side cover removed; (b) valve assembly installed.**

8. Turn off the carrier gas flow to the GC. Using the tubing cutter cut the 1/16" SS carrier gas line in the area shown in Figure 2-5a. Be sure that both ends of the tubing that you have just cut are open and burr free.

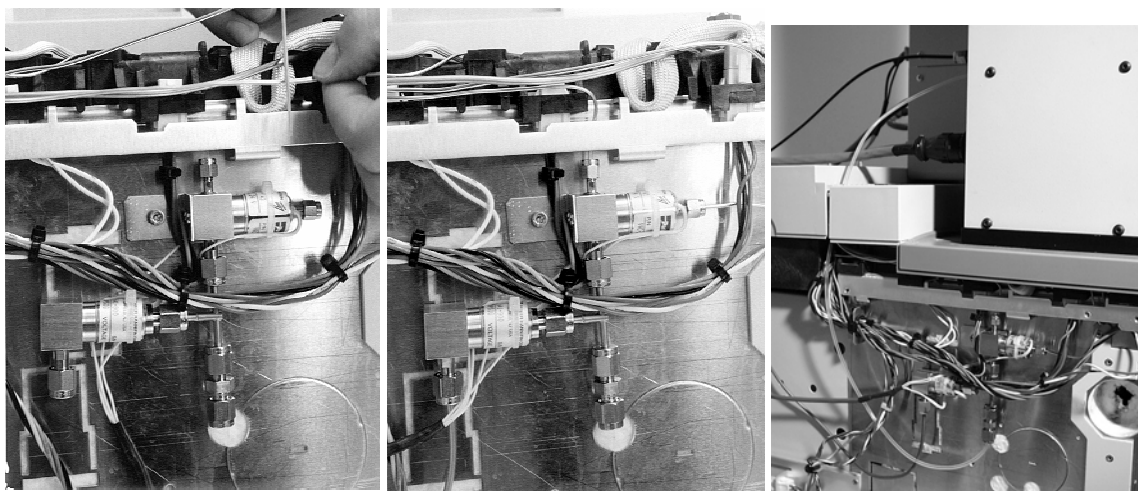

**Figure 2-5 – (a) Cutting GC carrier line; (b) Plumbing for valve assembly; (c) Route tubing from valve assembly to exit port**

9. Connect the ends of this carrier gas line into the valve assembly as shown in Figure 2-5b. Tighten the Swagelok fittings on the valves finger tight and then tighten with a wrench another 3/4 turn.

10. 1/8" flexible copper tubing is recommended for connecting the carrier gas from the tee fitting at the rear of the GC to the valve assembly as shown in Figure 2-5b. Cut a piece of the Teflon™ tubing supplied with the installation kit, approximately 24" long.

## 2 - Hardware Installation - Installation on the Agilent 6890 GC

Route the tubing from the valve assembly exit port labeled “To SPTD system” in Figure 2-5b behind the injection port fan as shown in Figure 2-5c.

11. Turn on the carrier flow to the GC and check for leaks at all fittings using SNOOP leak check fluid. If any leaks are present, retighten fittings and leak check again.

12. Route the electrical lead from the solenoid valve assembly out through the back of the GC. This will be connected to the Electronics Console later.

**Cryo-Trap Installation:** If you are installing an SIS Cryo-Trap please go to the **Cryo-Trap Installation** section later in this chapter for details. The Cryo-trap should be installed before proceeding further with the desorption system installation.

13. Replace the two cover plates that were previously removed.

14. Plug the remote start cable (Part #785016) into the back of the GC in either of the two connectors labeled “REMOTE”. The other end of this cable will be connected to the Electronics Console.

15. Attach the mounting plate (Part #78225) which is included with the Desorption Unit installation kit to the bottom of the Desorption Unit. The screws for securing this plate to the Desorption Unit are included with the plate. See Figure 2-6.

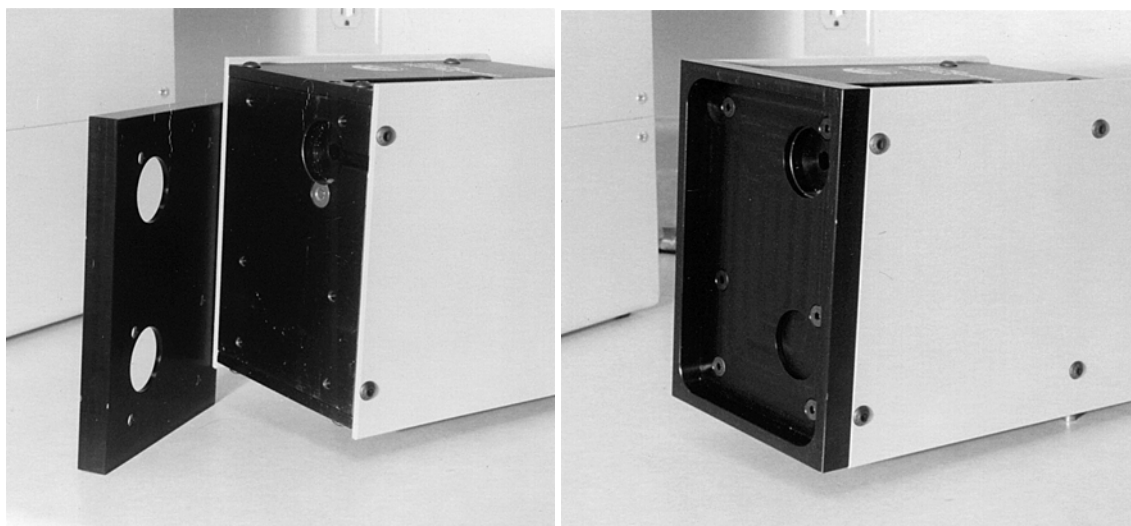

**Figure 2-6 – Attaching mounting plate to Desorption Unit.**

16. Place the septum nut adapter (Part #7811061) which is included in the installation kit over the GC septum nut.

17. Place the Desorption Unit onto the GC injection port. Align the Desorption Unit so that the counterbore in the mounting plate on the bottom of the Desorption Unit fits onto the septum nut adapter.

## 2 - Hardware Installation - Installation on the Agilent 6890 GC

18. The back of the Desorption Unit has two 1/8" Swagelok™ fittings for connection of the carrier gas and the air that is used to operate the TD-5 system. They are labeled AIR and GAS. Figure 2-7. Connect the free end of the Teflon™ tubing from the carrier gas solenoid valve assembly to the “GAS” fitting on the back of the Desorption Unit. Be sure that the tubing is fully seated in the fitting and then tighten 3/4 turn past finger tight.

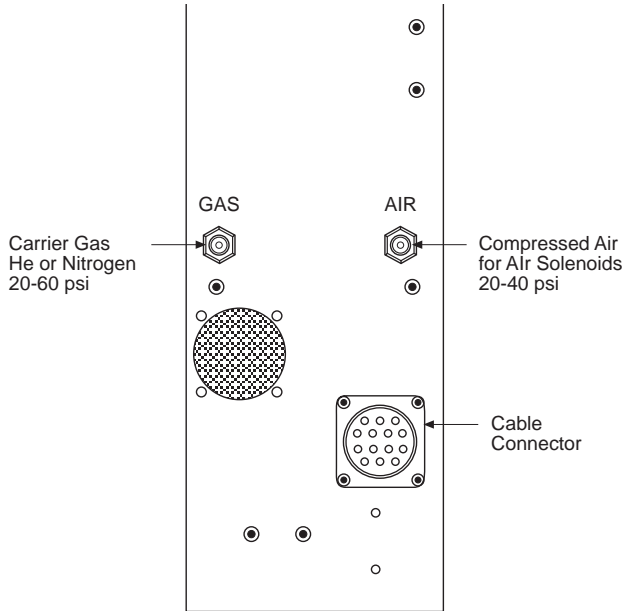

Figure 2-7 – Schematic showing the location of the gas inlets on the rear of the Desorption Unit.



Figure 2-8 – (a) 1/8" Teflon™ tubing is used for the carrier gas line and the compressed air line on the Desorption Unit; (b) Installation for the interconnect cable (#782010).

## 2 - Hardware Installation - Installation on the Agilent 6890 GC

**WARNING:** Do not use hydrogen as a carrier gas in this system. Keep Teflon™ tubing lines clear of GC exhaust and other areas which may be hot.

19. Cut an appropriate length of the Teflon™ tubing to connect the fitting labeled “AIR” on the Desorption Unit to the compressed air supply. Be sure the fitting is tight and leak free.

20. Plug the interconnect cable (Part #782010) into the back of the Desorption Unit. The cable is reversible so either end can be plugged into the Desorption Unit. See Figure 2-10.

### Installation of the Electronics Console

21. The Electronics Console can be positioned next to the unit as shown in Figure 2-9 or can be positioned on the bench next to the GC. Figure 2-10 shows the back of the Electronics Console.



**Figure 2-9 – TD-5 Desorption Unit installed on the Agilent 6890 injection port. Electronics Console is shown to its side (but may be placed elsewhere).**



**Figure 2-10 – Rear view of the Electronics Console.**

22. Plug the Interconnect Cable (large 14-pin round cable--#782010) into the appropriate connection on the back of the Electronics Console.

23. Plug the cable from the GC carrier gas solenoid valve (#7859993) into the fitting labeled “GC Valve” on the back of the Electronics Console.

24. Plug the remote cable (#785016) into the fitting labeled “Remote 1” on the back of the Electronics Console.

The fitting labeled Cryo-Trap is available if the user wishes to use the Cryo-Trap accessory.

25. Plug in the power cord from the back of the Electronics Console into a grounded 115V, 10 Amp outlet.

### ***Hookup to PC***

Connect the RS-232 communications cable to from the RS232 port on the Electronics Console to a free communications port on the PC. Another option to use a RS232 ↔ USB converter, which would allow the TD-5 to be controlled from spare USB port on the PC.

Refer to the “Setup” and “Standard Operating Procedures” sections of this manual for further instructions and operating procedures.

## ***Cryo-Trap Installation***

If a Cryo-Trap is to be used with the system, it should be installed first. The Cryo-Trap may be installed on either the front or rear inlet; however, the TD-5 system is designed to operate with the front inlet only. When installing any SIS Cryo-Trap, pay particular attention to the region where the heater and thermocouple cables enter the Cryo-Trap body. There is a spring-type strain relief mechanism at this point. It is important that the cable is not twisted or kinked in the region of the strain relief spring, as this may result in irreparable damage to the instrument.

1. Locate and unpack the Cryo-Trap and installation kit.
2. Remove the column from the inlet and cap it with a septum.

**NOTE-** These screws are subject to frequent temperature changes and have been known to bind in their holes. When extracting them, use care not to strip the threads.



**Figure 2-11 – Remove insulation cup from inlet**

3. Run the heater/thermocouple cable outside of the oven to the rear of the GC. A spare injection port can be used for this purpose, although one of the holes in the left-side oven wall is recommended. In order to pass the cable through one of these holes, the connectors may need to be removed. Pay particular attention to the wiring of the connectors if they are removed, and immediately reattach them to the cable once it is through the oven wall. Leave 3-4 inches of slack in the cable inside the oven to allow the Cryo-Trap to slide up and down the guide rods freely.

## 2 - Hardware Installation - Installation on the Agilent 6890 GC

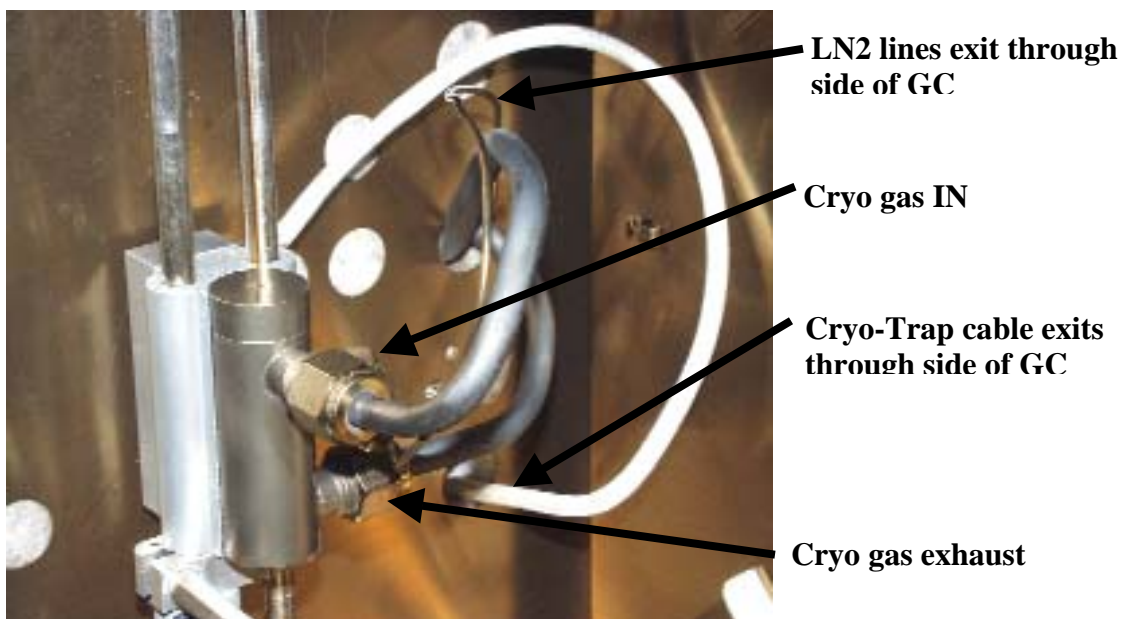

**Figure 2-12 – Run wires through hole in side of the GC (note: LN2 lines also exit the side of the GC oven)**

4.
  - a. After you have snaked the white cable (which holds the thermocouple and heater cable) and the CO<sub>2</sub>/LN<sub>2</sub> line through the oven wall and connected the CO<sub>2</sub>/LN<sub>2</sub> valve, lay the Cryo-Trap body flat on the floor of the GC oven.
  - b. Run your capillary column through the Cryo-Trap, pull it through and put the ferrule on the capillary, cut flush, inspect under magnifying glass and tighten the column nut into the injector. Make sure you ensure there is some extra capillary length (“slack”) to allow the capillary to flex. Maybe unwind the capillary one revolution from the cage.
  - c. Pick up the Cryo-Trap and slowly move it up to the column nut and tighten the hex shaped tightener around the column nut. Here it is helpful to have an assistant push the Cryo-Trap up vertically while you tighten the hex shaped tightener. The brown Vespel™ piece will constrict down on the column nut. It might be a little hard to do alone.
  - d. You may want to tighten the column nut the following day just a small turn as the heat from the injection.

**WARNING: TO AVOID PERSONAL INJURY, THE CRYOGEN EXIT MUST BE DIRECTED TO THE REAR OF THE GC OVEN!**

5. For installation on the HP 5890 GC, the small stop collar may be installed at the level of the MS transfer line to prevent the Cryo-Trap from accidentally breaking the column by sliding down too far.

## 2 - Hardware Installation - Installation on the Agilent 6890 GC

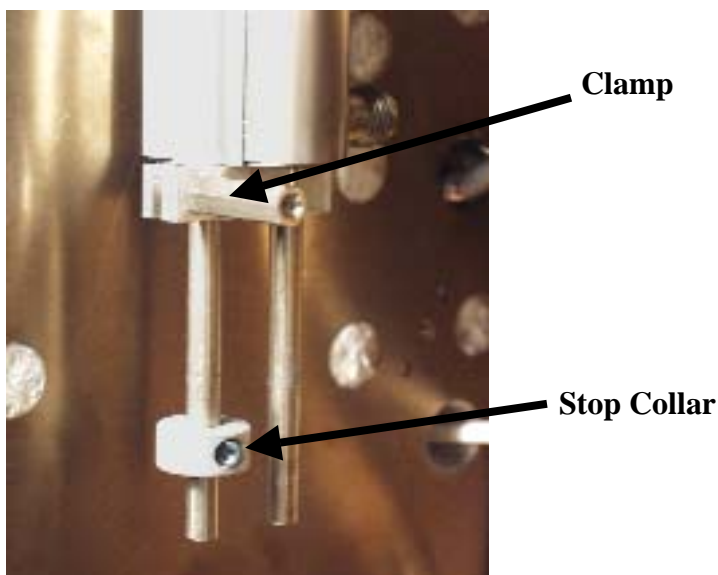

Figure 2-13 – Stop collar and clamp for cryo-trap

6. Plumb cryogen supply and exhaust lines from the Cryo-Trap outward. A spare injection port may be used; however, use of the holes in the left oven wall makes for a much neater installation. Cryogen should be supplied to the Cryo-Trap through the  $\frac{1}{4}$ " swagelok opening that points toward the right side of the GC. The other  $\frac{1}{4}$ " swagelok fitting (pointing toward the rear of the GC) should be used for venting the trap, if necessary. Installing the Cryo-Trap in another orientation may result in failure of the Cryo-Trap, or inability for the GC to control oven temperature.

**\*NOTE** – Liquid  $N_2$  ( $LN_2$ ) coolant must be supplied by  $\frac{1}{4}$ " tubing (flexible copper is best) and must be vented from the Cryo-Trap outlet outside the oven. A short piece of tubing run through the same hole as the coolant supply is sufficient.

**WARNING:** DIRECT THE  $LN_2$  VENT LINE AWAY FROM AREAS WHERE PERSONAL CONTACT WITH THE VENTED COOLANT IS POSSIBLE. INSURE ADEQUATE VENTILATION IN AREAS WHERE  $LN_2$  COOLANT IS USED.

**\*NOTE** – Liquid  $CO_2$  coolant is supplied from the valve through  $1/16$ " stainless steel tubing. It is generally not necessary to vent the Cryo-Trap when using  $CO_2$  unless difficulty controlling oven temperature is encountered.

**WARNING:** AVOID CONTACT WITH LIQUID  $CO_2$ . NEVER OPEN THE GC OVEN WHILE CRYO-TRAP IS IN COOLING MODE. INSURE ADEQUATE VENTILATION IN AREAS WHERE LIQUID  $CO_2$  COOLANT IS USED



## 2 - Hardware Installation - Installation on the Agilent 6890 GC

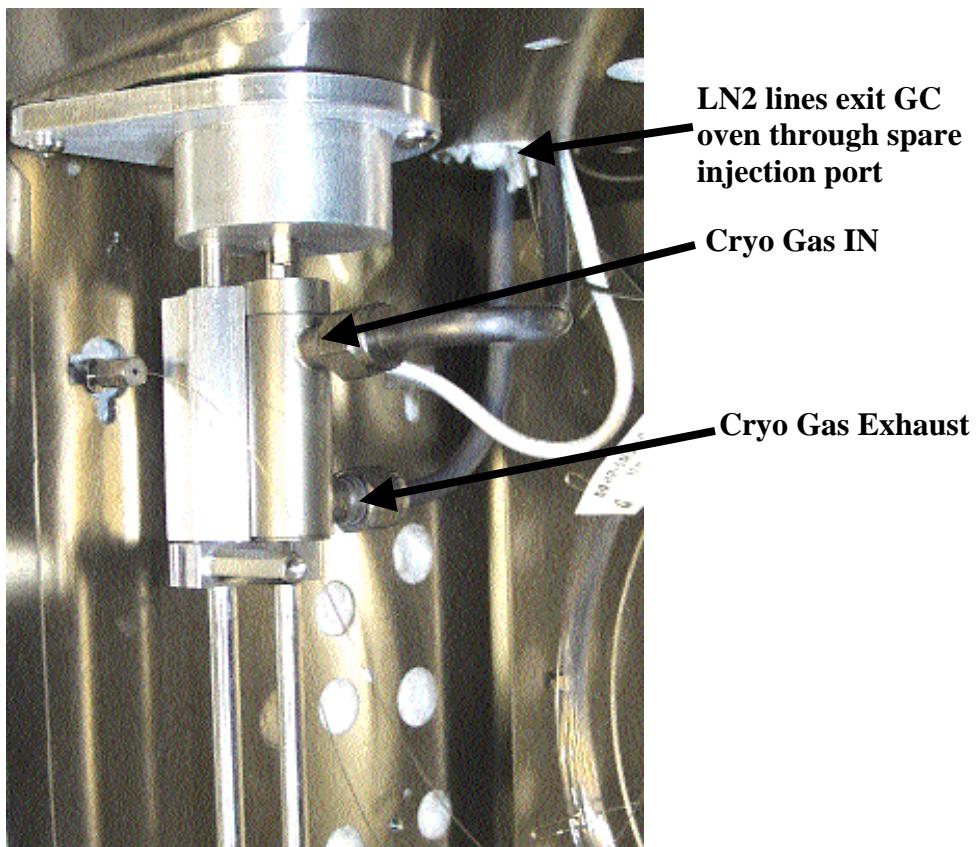

**Figure 2-14 – Cryo-Trap installed.**

7. Run cryogen supply and exhaust lines as well as the heater/thermocouple cable along the side of the GC toward the rear of the instrument. Cutouts in the back plate may be removed to make room for the lines to exit the back of the GC.
8. Connect the cryogen supply tube to the outlet of the appropriate valve. When using LN<sub>2</sub>, **insulate the valve body and the length of tubing that runs from the valve to the oven wall.** Plumb the valve to the cryogen supply.

## ***Installation on other top loading GCs***

The TD-5 can be installed on most top loading gas chromatographs. For example the system has been installed on the Varian 3700 and the PerkinElmer AutoSystem GC. Please call our customer support personnel for help in installing the desorption system on these gas chromatographs.

The TD-5 is manufactured to provide a variety of options for mounting and installation. The bottom plate of the Desorption Unit has six drilled and tapped holes into which spacers or standoffs can be attached to provide legs for the desorption unit if required (Figure 2-15). These tapped holes enable the user to adapt the thermal desorption unit to most models of GCs. By attaching #10-32 machine bolts with washers, standoffs or other suitable spacers, the height of the Desorption Unit from the top of the GC injection port can be adjusted. These drilled and tapped holes also permit the user to permanently attach the Desorption Unit to the GC cover if so desired. However this is not normally necessary, and is not recommended. Gravity firmly holds the Desorption Unit in place. It will not move or tip over even when injecting through hard 3-layer type septa.

Custom septum nuts, adapter fittings, and spacers can be custom manufactured by S.I.S. to adapt various models of GCs to the desorption system. Custom mounting plates can be designed and fabricated to fit a particular instrument. Please call SIS customer support personnel for further information.

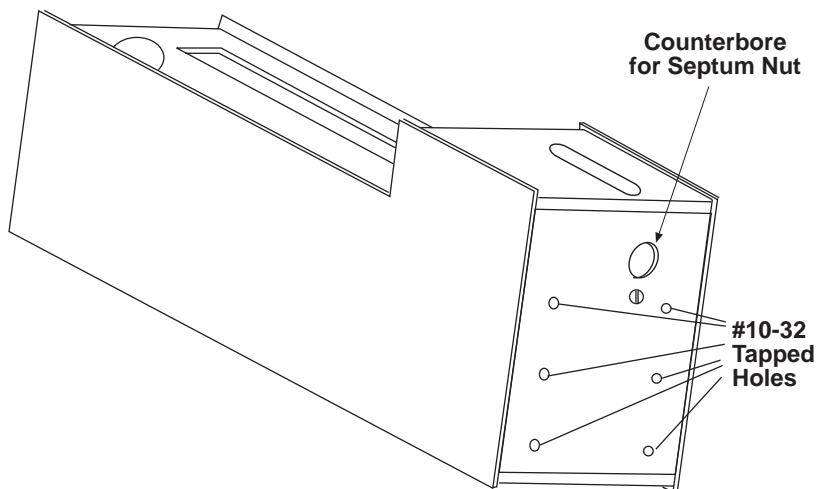

**Figure 2-15 – Tapped holes on bottom of Desorption Unit aid in installation.**

## ***Next Steps***

With the TD-5 hardware installed, you are now ready to install the Thermal Desorption Software as described in the next section. (It is also possible to install the software before the hardware is installed.)

## 2 - Hardware Installation

## 3. Software Installation

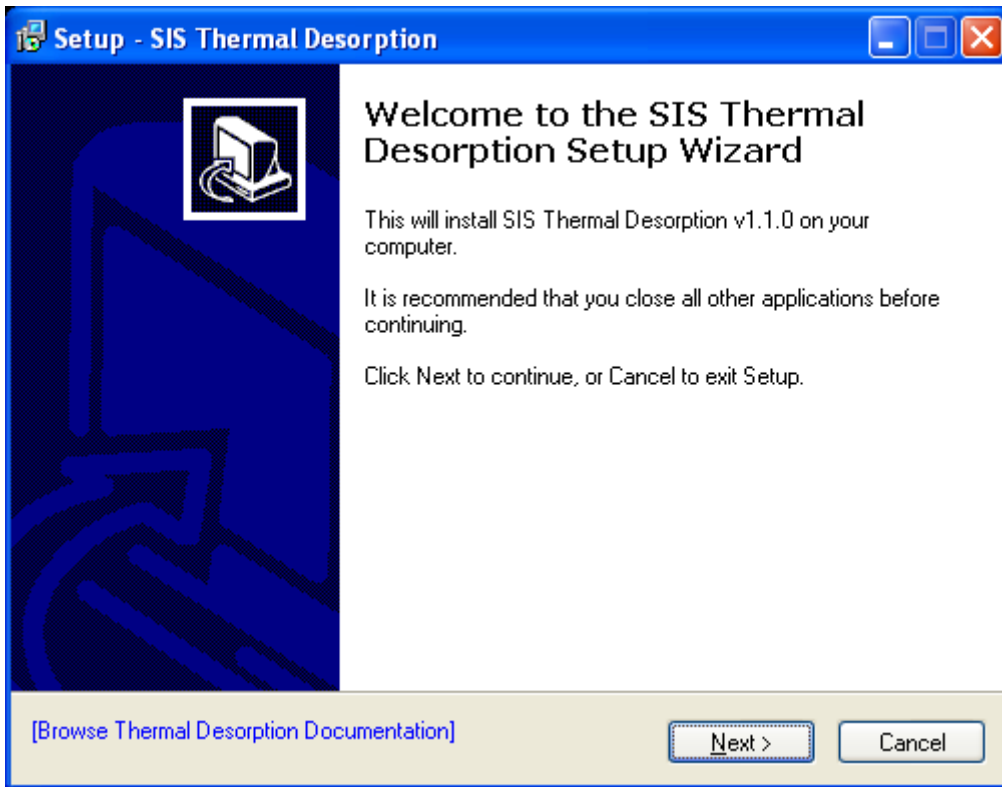

Figure 3-1 – Welcome Page for installation of the Thermal Desorption Software.

### **Overview**

This section describes the installation process for the **Thermal Desorption Software** (Figure 1-7). See Chapter 1 for background information on this software. Installation of the software may be done before or after installation of the hardware (Chapter 2).

Note: the screenshots in this section might vary slightly from those you see.

### **Installation**

Insert the SIS Thermal Desorption Software CD. Typically, the window in Figure 3-1 will display.

(If window does not display automatically, select from the **Windows Taskbar** the menu item **“Start | Run...”** and then enter **“D:\setup.exe”** where “D” is replaced by the drive letter of your CD-ROM drive on your system.)

Note: At any time, you can optionally click the blue **“Browse Thermal Desorption Documentation”** link to view the online documentation.

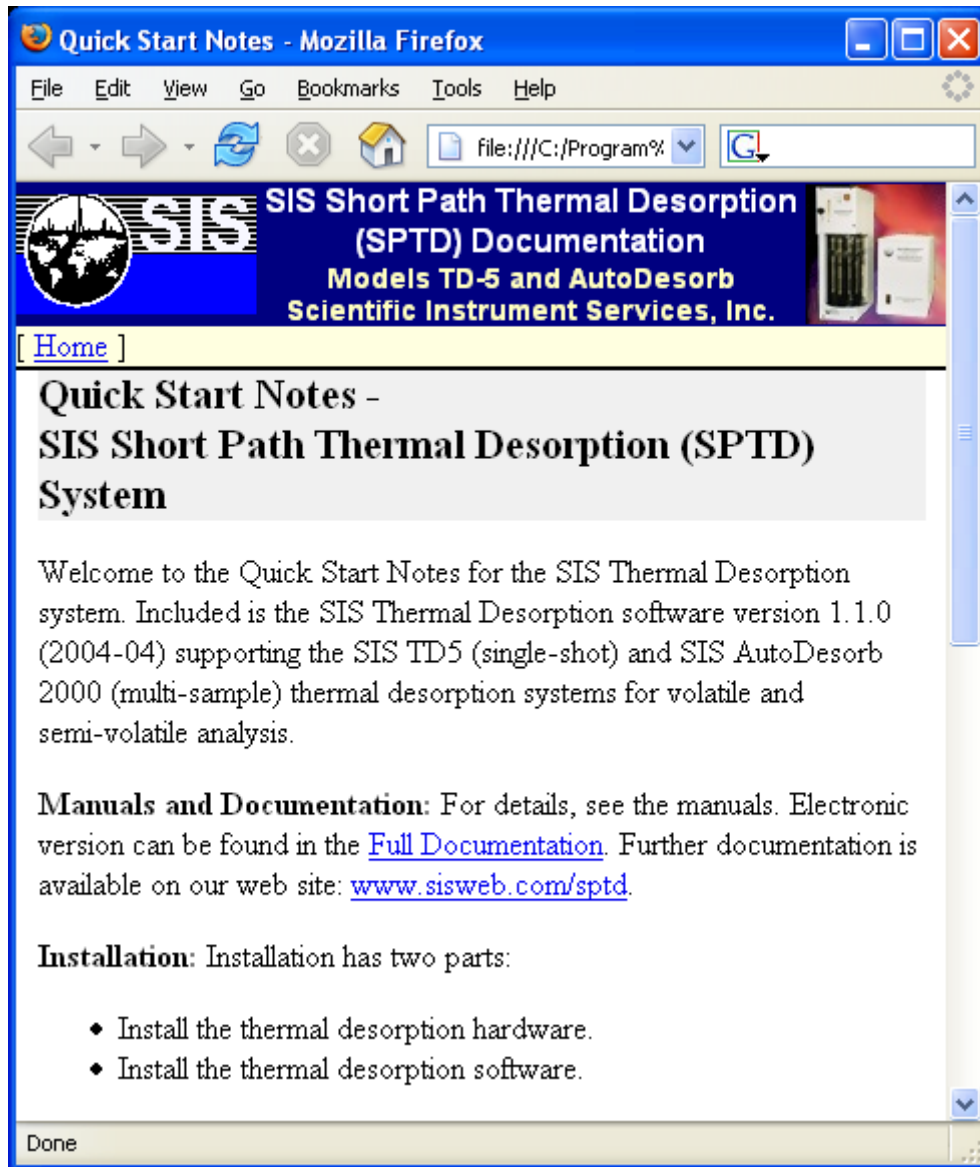
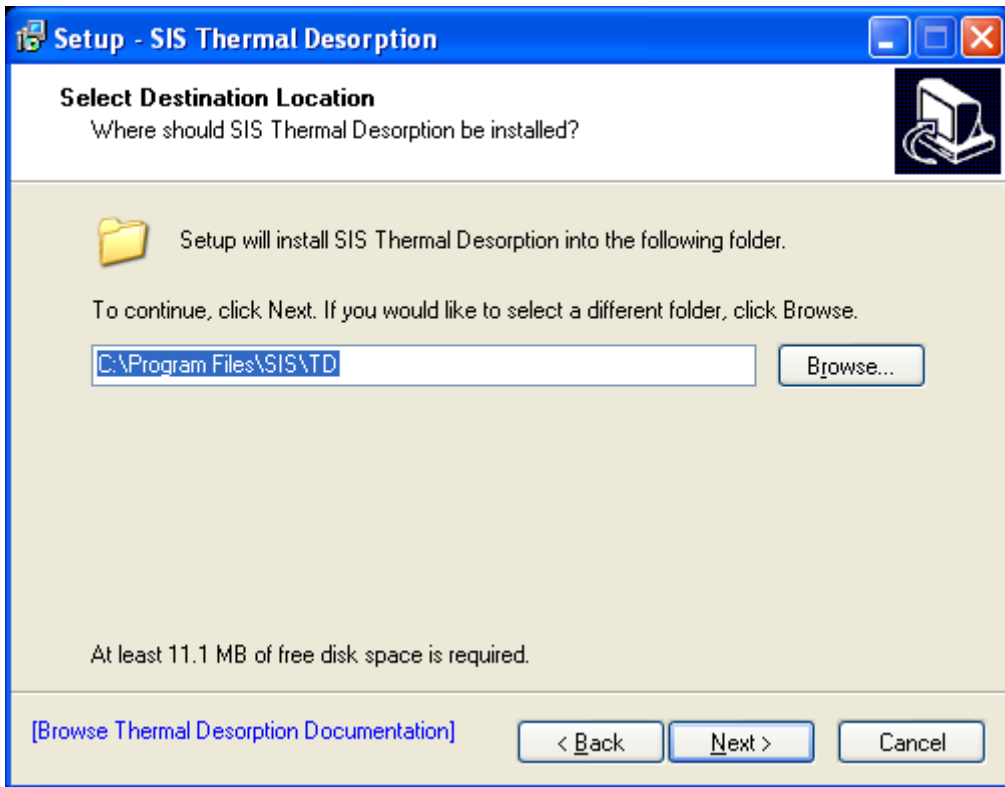

Figure 3-2 – Online documentation

The first part of the installation process is fairly typical. Press **Next** on the installation screen shown in Figure 3-1.

### 3 - Software Installation



**Figure 3-3 – Installation program, selection of installation location.**

The default installation location for this software is at “C:\Program Files\SIS\TD”, but you may change this to any location as shown in Figure 3-3. Press **Next**. When the window in Figure 3-4 displays, press **Install**.

### 3 - Software Installation

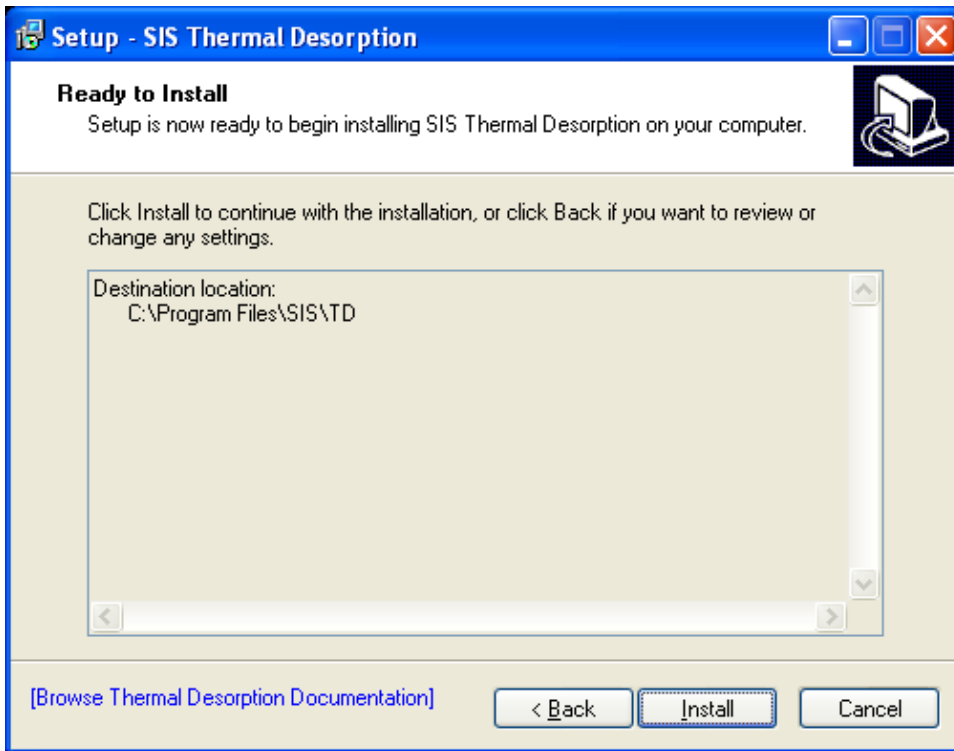

Figure 3-4 – Installation program, confirmation page

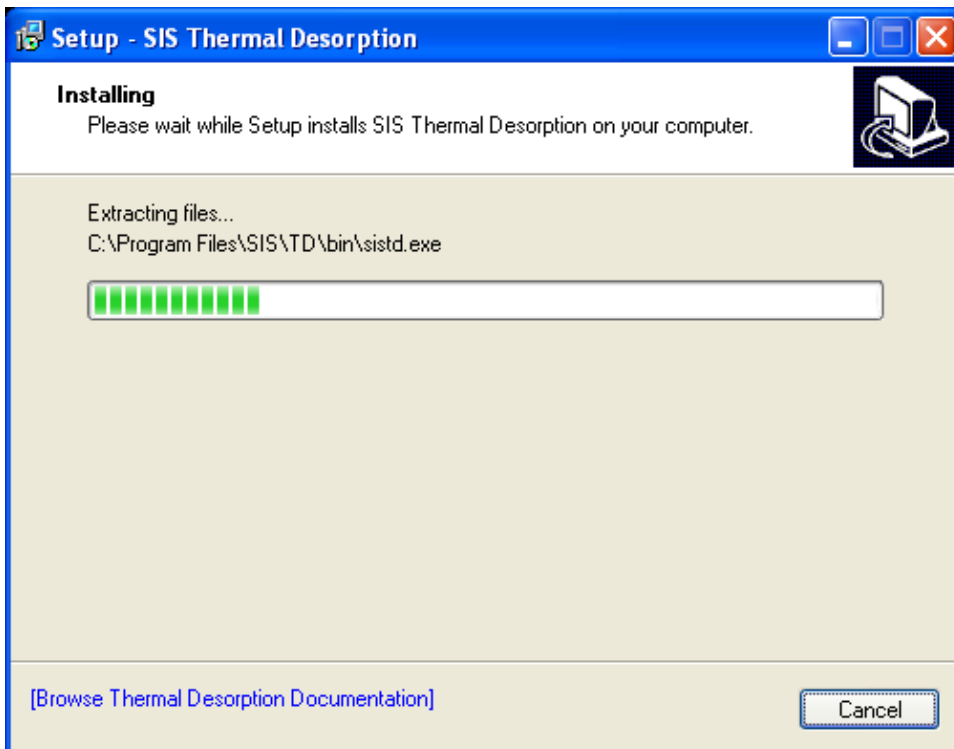
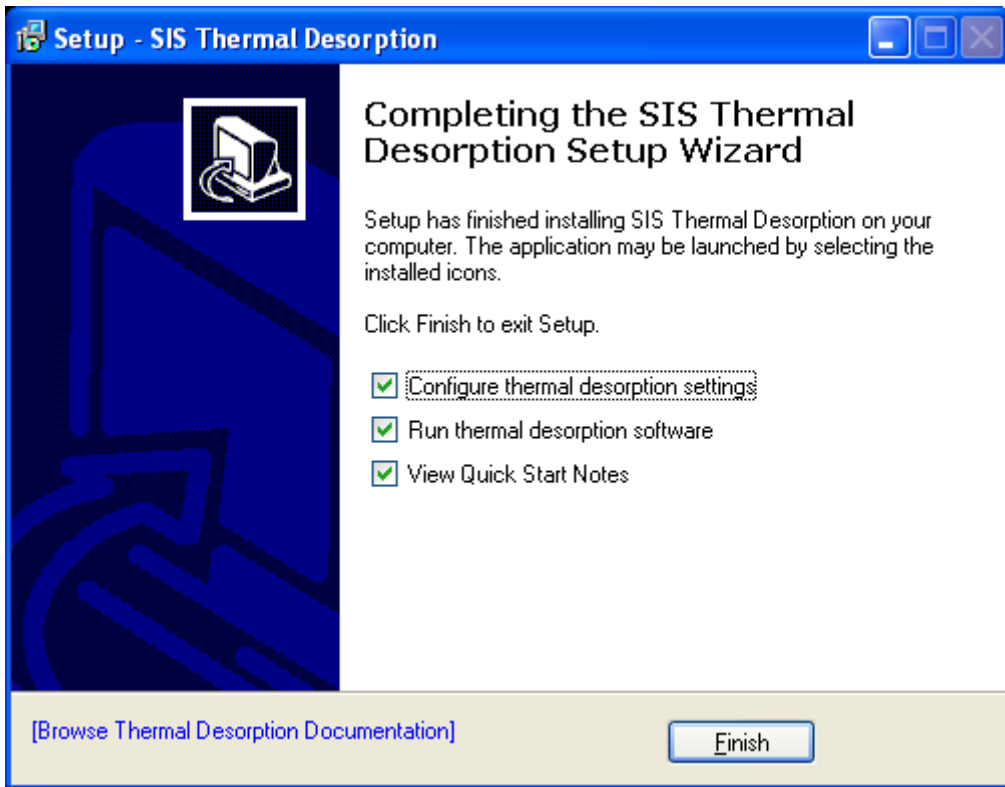

Figure 3-5 – Installation program, installing files



### 3 - Software Installation



**Figure 3-6 – Installation program, installation complete.**

The software is installed, and the window in Figure 3-6 displays. The software still must be configured.

## Configuration

It is now time to configure the software. The Configure System window (Figure 3-7) will display following the installation.

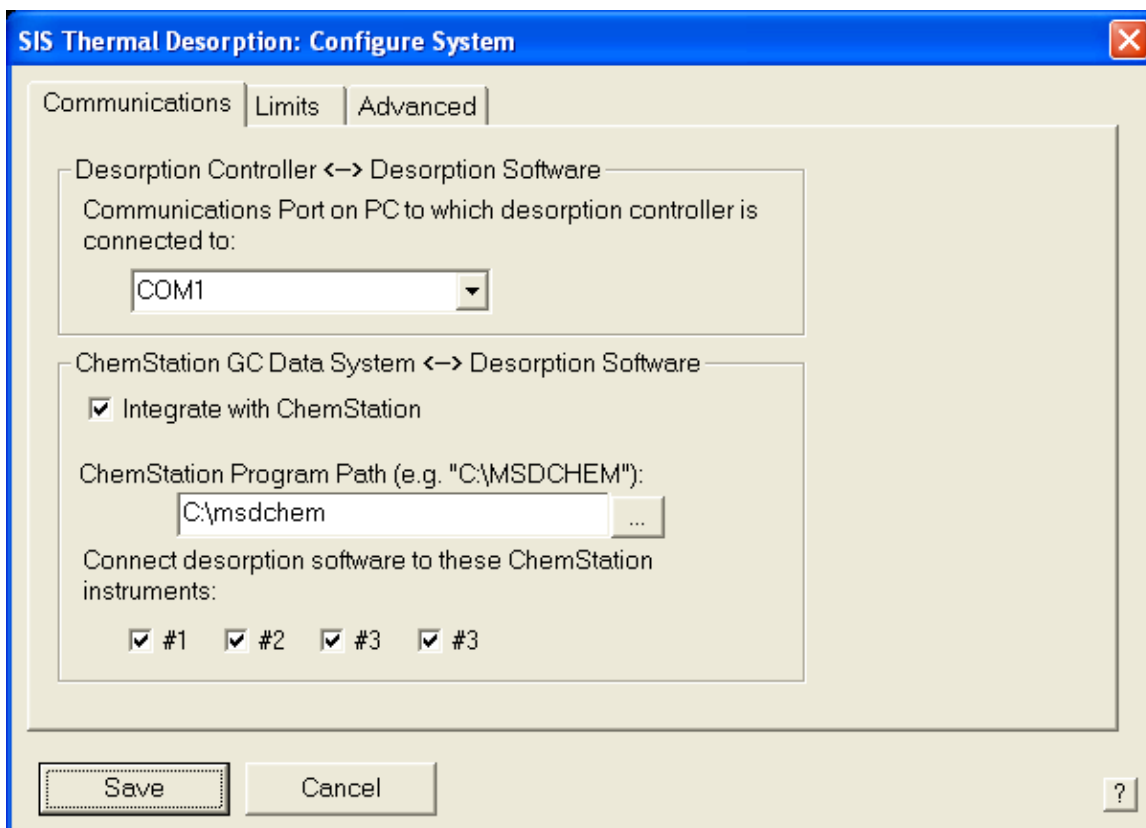

Figure 3-7 – Configure System window

Only two items need be configured at this time:

- The **communications port**
- The **ChemStation program path** (only if you wish to use the software in integrated mode with the Agilent ChemStation GC data system).

Both of these items display on the “**Communications**” Tab.

Note: These items and others can be changed at any later time. In particular, the configuration window is accessible from the **Windows Start Menu (“Programs | SIS Thermal Desorption | SIS Thermal Desorption | Configure”)** as shown in Figure 3-9.

## ***ChemStation Integration***

The thermal desorption software interfaces to Agilent (HP) ChemStation via ChemStation macros. The thermal desorption software installs its own macros (sistd.mac) and makes a few minor modifications to the standard ChemStation macros.

As shown in Figure 3-7, ChemStation integration is enabled by checking the “**Integrate with ChemStation**” checkbox. You must specify the **ChemStation Program Path** (typically, “C:\MSDCHEM”) in order that the thermal desorption software knows which ChemStation files to modify. In addition, you can enable/disable the thermal desorption system only on specific ChemStation instrument numbers. By default, all instrument numbers are enabled (note: there is no harm if certain instrument numbers do not exist).

When pressing **Save**, the thermal desorption software will attempt to update the ChemStation macros. If successful, you will see a series of dialog boxes as shown in Figure 3-8.

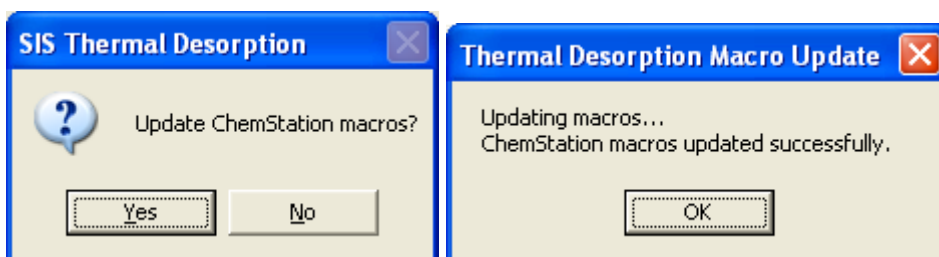

Figure 3-8 – updating ChemStation macros

## ***Reinstalling or Upgrading ChemStation***

**Warning:** If you ever reinstall, upgrade, or move ChemStation, you will need to re-update the ChemStation macros since they may have been overwritten. This can be done by removing and re-enabling ChemStation integration (i.e. disable **Integrate with ChemStation**, do a **Save**, **Enable Integrate with ChemStation**, and do a **Save** again).

## ***Starting the Thermal Desorption Software***

The thermal desorption software is by default set to start automatically following the installation and configuration. The software can also be started from the Windows Start Menu | Programs | SIS Thermal Desorption | SIS Thermal Desorption Program as shown in Figure 3-9.

### 3 - Software Installation

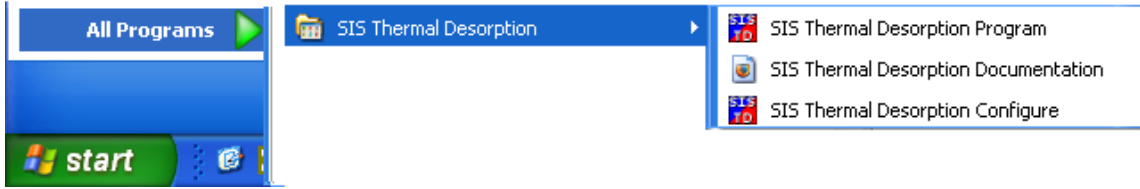

**Figure 3-9 – Accessing the thermal desorption software from the Windows Start Menu.**

### 3 - Software Installation

# 4. Desorption Unit Description

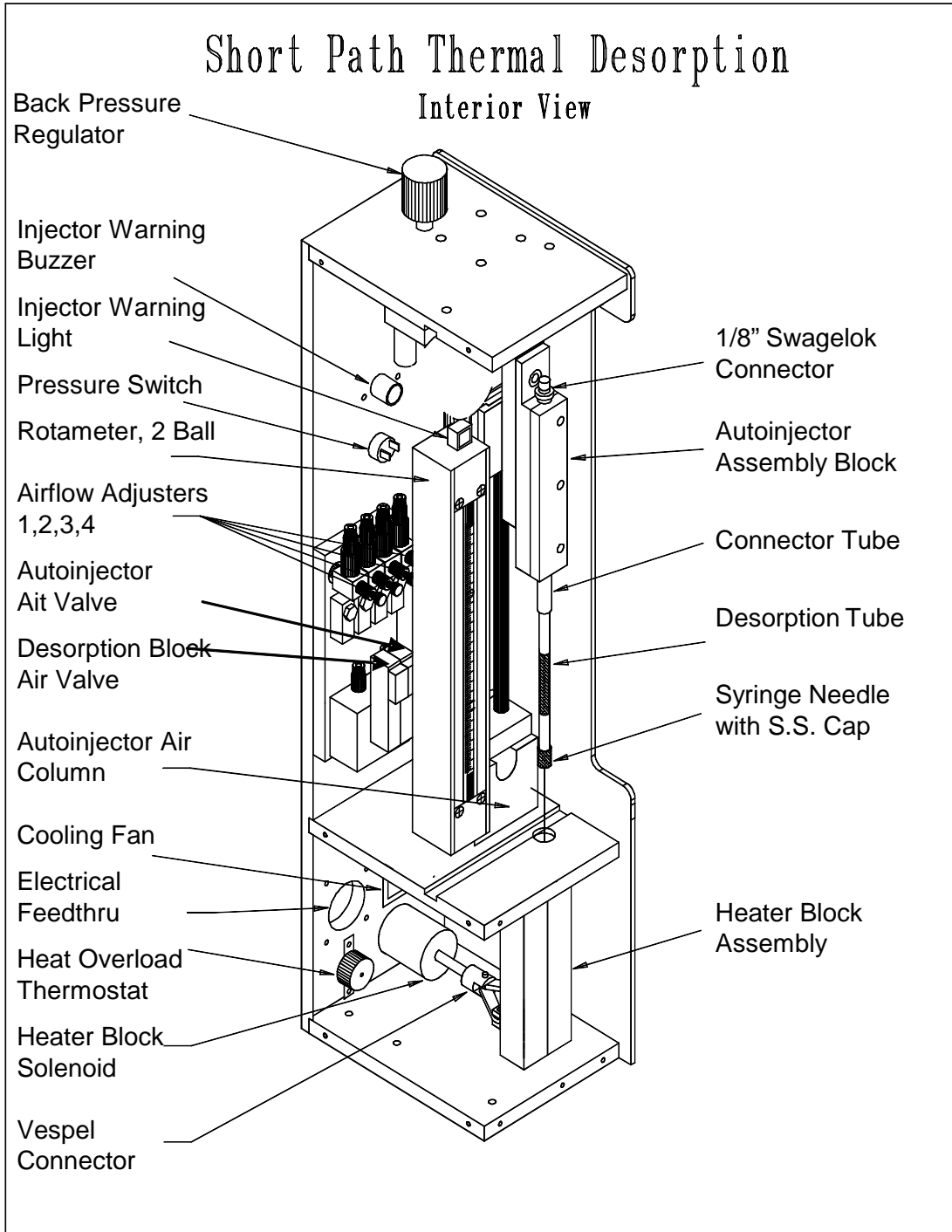

Figure 4-1 – Components of TD-5 Desorption Unit.

### **Overview**

This chapter details the components and characteristics of the Desorption Unit (Figure 4-1). See Chapter 1 for background on the Desorption Unit.

### **Description of Desorption Unit**

The Desorption Unit is designed as a compact self contained injection and thermal desorption system that mounts directly over the GC injection port. The auto-injector permits the user to inject the desorption tube with needle attached into the GC injection port. The desorption tube and needle are attached to the auto-injector assembly and (when activated) carrier gas flows through the tube and needle continuously. The carrier gas flow through the desorption tube is regulated by a flow controller valve mounted on the top of the Desorption Unit. The flow can be monitored by the two ball rotameter on the front of the Desorption Unit, and the pressure (measured by the pressure gauge inside the Desorption Unit) displays in the Status window on the Thermal Desorption software. The rotameter enables the measurement of carrier gas flows between 1 and 120 ml/min. The pressure gauge permits the measurement of carrier gas pressures at the top of the desorption tube between 0 and 75 psi. The front viewport at the bottom of the Desorption Unit permits the easy viewing of the injection port and desorption tube when injected and also provides for the cooling of the desorption tube when the desorption heater block is not activated. It can be easily observed that the needle is proceeding properly into the GC injection port and that the Desorption Unit is properly aligned with the GC injection port.

The Desorption Unit is designed with a wide variety of components built into the case (Figure 4-1). The carrier gas flow system inside the desorption cabinet consists of a valve, a flow controller, a pressure gauge, and a 2-ball rotameter. The auto-injecting system consists of a valve, an auto-injector air slide column, and assembly block. The desorbing system consists of a solenoid and the heater block assembly. In addition, a cooling fan maintains the temperature inside the cabinet and a heat overload thermostat provides protection from system overheating.

Samples to be analyzed are collected inside the desorption tubes described later. When the desorption tube is ready to be analyzed, a needle is attached to the desorption tube and the tube is attached to the connecting tube on the auto-injector assembly on the Desorption Unit (LOAD POSITION). The carrier gas through the Desorption Unit is turned on via the Electronics Console. The flow through the desorption tube is adjusted with the flow controller and monitored by the rotameter and/or the pressure gauge. The desorption tube and needle are then injected into the GC inlet (INJECT POSITION).

When injection is complete, the flows are readjusted as required by the method of analysis (i.e. split/splitless, etc.). In this position the sample is not being desorbed into the GC since the heating blocks have not yet closed around the desorption tube. The temperature of the tube remains close to room temperature due to the action of the cooling fan. Carrier gas flows, desorption temperatures, and GC parameters can be adjusted as required.

#### 4 - Desorption Unit Description

The microprocessor control actuates a valve which moves the hinged heating blocks from the open to the closed position around the desorption tube (HEAT & DESORB POSITION). The tube ballistically heats up to the set temperature or the temperature program ramp for the heater blocks begins. The combination of the heat applied and the carrier gas flow through the desorption tube extracts the desired components into the GC injection port and onto the front of the GC column.

The various parameters are set and used according to the application requirements. Normally desorption temperatures between 70°C and 250°C are suitable for most applications.

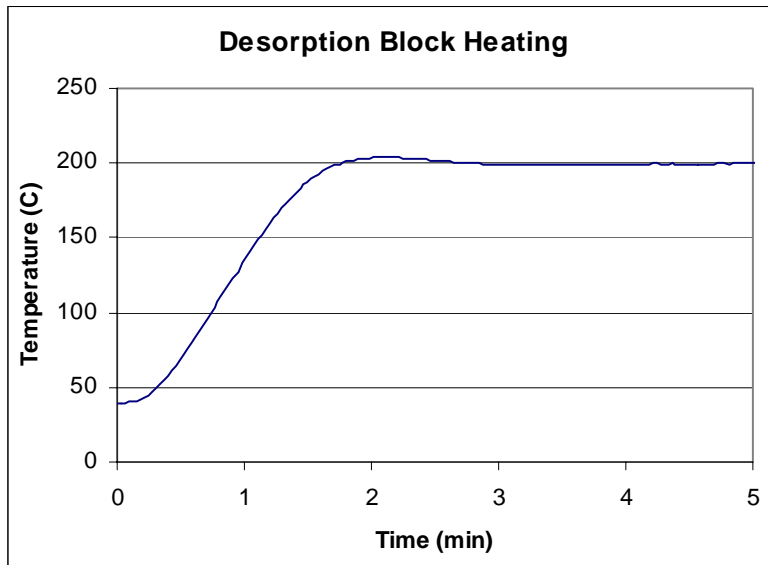

Figure 4-2 – Desorption Block Heating



#### 4 - Desorption Unit Description

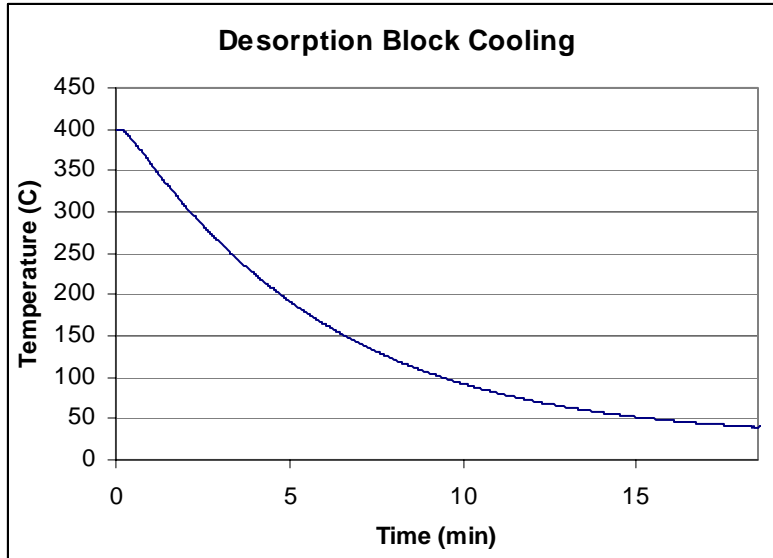

Figure 4-3 - Desorption Block Cooling

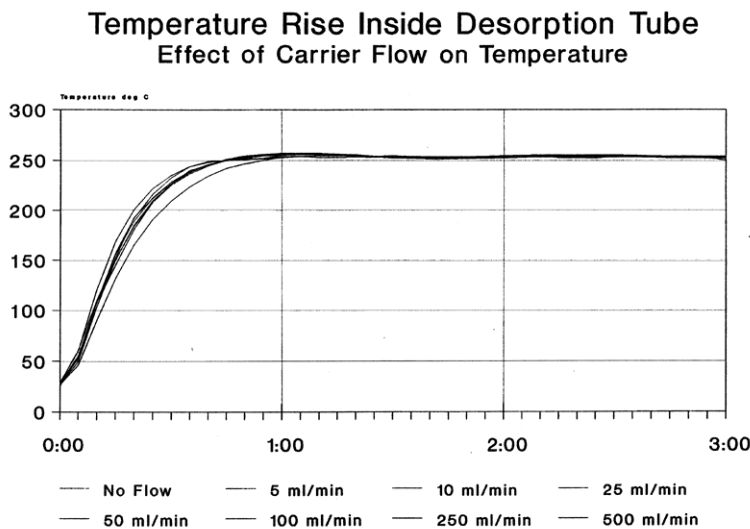

Figure 4-4 - Temperature Rise inside Desorption Tube - Effect of Carrier Flow on Temperature

The heater blocks can be ballistically heated or temperature programmed at ramp rates up to 100°C/min. Normal desorption times vary from 3 minutes to 15 minutes, however longer desorption times up to 100 minutes are permitted. Carrier flow through the desorption tube can be accurately adjusted from 1.0 ml/min to 110 ml/min using the two-ball rotameter and flow controller (i.e. 1.0 ml/min for direct splitless analysis and 100 ml/min for split methods permitting split ratios of 1 to 100). Since the column is normally maintained at subambient temperatures, the desorbed compounds of interest are trapped on the front of the GC column in a narrow band. Despite the long desorption times, the peaks eluted from the column are extremely sharp and well resolved.

## 4 - Desorption Unit Description

The Cryo-Trap can be purchased as an accessory for the TD-5 System. The Cryo-Trap consists of a small heating/cooling chamber which is 3/4" in diameter and 2" long. In the center of the chamber is a small stainless steel capillary through which the fused silica capillary column freely passes. Capillary columns up to megabore (0.53mm I.D.) diameters can be used. Around the stainless steel capillary tube a heating coil is wound to provide for the rapid heating of the capillary tube. A thermocouple provides accurate measurement of both the cooling and heating temperatures. Either liquid CO<sub>2</sub> or liquid nitrogen for cooling is introduced into the Cryo-Trap and is exhausted through the outlet, which can either be vented either into the GC or outside the oven. Control of the Cryo-Trap is provided by output signals from the Desorption Unit.

### ***Auto-injector Description***

Use of the auto-injector, which is controlled by the Electronics Console, permits the injection and removal of the needle assembly from the GC injection port without physically handling the desorption tube during the injection process. This is quite important, since the tube is often at 250°C or higher after the sample has been desorbed. After injection and desorption of the sample into the GC, it is important not to touch the desorption tube immediately after its removal from the injection port. Allow it to cool a minimum of 5 minutes after the end of the heating cycle.

The desorption tube and needle assembly is self aligning when the Desorption Unit is set in place over the GC injection port nut. The end of the needle should line up with the approximate center of the passage hole in the middle plate of the desorption unit base. The straight injection motion of the auto-injector and the cone shaped design of the GC septum nut provide for accurate needle penetration through the GC septum. The weight of the Desorption Unit is sufficient to maintain the position of the unit during injection, even through hard rubber septa. Compressed air from laboratory system supplies or from commercially available tanks may be used for the Desorption Unit. If compressed air is used for the flame ionization detector on the GC, this supply may also be used to provide the air for the Desorption Unit. The TD-5, however, will use relatively large quantities of compressed air. Gas pressures between 40 and 60 psi are required to activate the auto-injector. For prolonged life, the gas supplied to the auto-injector should be filtered to contain no particles larger than 50 microns. A standard laboratory air filter will normally provide for this purity. Water traps are also recommended.

NOTE - Adjustments to the auto-injector should be performed by a technician knowledgeable in these systems. Extreme caution must be exercised when adjusting the system. Moving parts of the auto-injector that are under high pressure can be dangerous. It is **RECOMMENDED THAT THE DESORPTION UNIT BE SERVICED BY A TRAINED TECHNICIAN AT S.I.S.** when adjustment is required. S.I.S. is not responsible for damage done by untrained individuals making system adjustments.

### ***Heater (Desorption) Block Operation***

The heater block assembly closes around the desorption tube and the tube is heated to release the sample volatile components into the carrier gas as it passes through.

The heater blocks have a high coefficient of heat transfer so the heater block assembly can be quickly heated and cooled during operation. Due to this ability to rapidly heat and cool it is not necessary to leave the heaters on continuously. The heaters should be turned off when not in use, especially when unattended overnight. This will prolong the life of the heaters and related circuitry. The blocks normally will return to room temperature between samples and when not in use. **DO NOT** leave heaters on overnight.

Each of the heating blocks is provided with a 300 watt cartridge heater. The desorption block assembly also includes a 100 ohm platinum resistance thermometer (PRT) mounted in one of the aluminum blocks. The PRT provides feedback to enable the Electronics Console to regulate the temperature as well as provide an accurate temperature indication for the desorption block assembly. The PRT enables temperature control of the heating blocks to within  $\pm 1^{\circ}\text{C}$ , and over a range from room temperature to  $400^{\circ}\text{C}$ .

Figure 4-2 shows the rate of heating of the desorption block assembly. When the system is first turned on and the desorption block temperature is set via the Thermal Desorption Software, the final temperature can be achieved within a few minutes, indicating that the system is ready for injection and desorption of samples. The auto tuning feature of the temperature controller quickly adjusts the block temperature to its set position with minimal cycling.

The next chart (Figure 4-3) indicates the rate of cooling for the desorption blocks. Beginning at an initial temperature of  $400^{\circ}\text{C}$ , the desorption heaters were turned off, and allowed to cool via air circulation provided by the internal cooling fan. The desorption blocks cooled down close to room temperature after about  $\sim 15$  minutes depending on starting temperature. This is the recommended time to allow the system to cool before the main power switch on the Electronics Console is turned off. By leaving the main power switch on, the cooling fan will continue to circulate and cool the Desorption Unit after the heating blocks are turned off. This routine cooling sequence will provide for maximum life and performance of the TD-5.

The next chart indicates the rate of temperature rise within the interior of the desorption tube (Figure 4-4). Temperatures were measured in the center of the desorption tube with a 0.010" diameter Type J thermocouple. Studies were performed at a wide variety of carrier gas flows through the desorption tube to test the effect of the gas flow on the rate of heating. The lowest line on the curve between 20 and 50 seconds is the rate of temperature with no carrier flow through the desorption tube. The remaining curves are superimposable. The rate of carrier gas flow through the desorption tubes appears to have no effect on the rate of heating or on the final temperature of the interior of the desorption tubes over the flow range of 5 ml/min to 500 ml/min tested. The desorption tube interior heats up rapidly, at a rate greater than  $200^{\circ}/\text{min.}$ , and the final temperature is reached in

## 4 - Desorption Unit Description

less than 1 minute. Samples need to be desorbed for at least 1.0 minute to reach a temperature of 250°C. Additional desorbing time will purge the required components from the adsorbent medium during this time. Samples should be desorbed a minimum of 5 minutes at an appropriate temperature to achieve maximum recovery of the higher boiling components. Experiments have also shown that the rates of heating of the 3.0mm I.D. desorption tube and the 4.0mm I.D. desorption tube are near identical.

**The maximum desorption temperature permissible with the system is 400°C**, and in no case should an attempt be made to exceed this. A manual heat overload thermostat is located on the back plate of the desorption unit base to protect the desorption unit from overheating. This thermostat is wired in series with the cartridge heaters. In the event the temperature at the thermostat exceeds 60°C, the circuit will be opened and the heater blocks will no longer be heated until the temperature inside the desorption unit falls below this temperature level. In order to restore the heating capabilities of the desorption system, the left side of the desorption cabinet must be removed and the thermostat reset button pushed IN to reset the desorption system heaters. In the event of repeated tripping of the heat overload thermostat, both the Desorption Unit and Electronics console should be returned to the factory for servicing.

The heater blocks for the TD-5 can be programmed to heat up between two temperatures at ramp rates of up to 100°C/ min. It is often desirable, especially in direct thermal extraction (DTE) methods, to ramp the desorption temperature and avoid exposing lighter volatiles to extreme heat.

### ***Carrier Gas Flow & Regulation***

The carrier gas supplied to your GC is used in the TD-5 to purge samples into the GC injection port. The TD-5 was designed for systems that use helium or nitrogen carrier. In **NO case should hydrogen be used** in the TD-5 due to the possibility of explosion.

A solenoid valve that can be activated from the Electronics Console controls carrier flow in the Desorption Unit.

The carrier gas flow regulator (located on top of the Desorption Unit) is a mass flow control device capable of accurately delivering a set gas flow regardless of changes in downstream pressure. The regulator is normally configured to deliver flow rates between 1 and 110 ml/min, however other configurations are available. Contact SIS technical support for more information.

### ***Rotameter***

A two ball rotameter is mounted on the front panel of the Thermal Desorption Unit (Figure 4-1) and permits the visual indication of the carrier gas flow. The 150 mm flow tube contains a glass ball for flow ranges of 0 to 30 ml/min of air and a second carboly ball for flow ranges of 0 to 130 ml/min of air (See Figure 4-8). If required other flow range tubes can be factory installed in the desorption unit. Contact SIS for additional

#### 4 - Desorption Unit Description

details. No special maintenance is normally required for the rotameter. Dirt or contamination may create problems within the flow tube by causing a restriction in the flow passage. Such conditions can be easily diagnosed by examining the flow tube.

The most obvious indication of obstruction is if the ball is stuck in the flow tube. If the existence of contamination is determined it will be necessary to remove the flow tube from the frame and disassemble the float and top and bottom retaining plugs from the flow tube. Use tweezers to handle the floats and the plugs and store them in a container with a lint free surface. Note the order of removal of the two balls so that they can later be reinserted in the same order. Using an ultrasonic cleaner, clean all parts including the flow tube, rinse and thoroughly dry. Reinsert the parts and test for free motion before reinstalling in the system.

In addition to permitting the visual regulation of the carrier gas flow through the desorption unit, the rotameter is used to sense when problems are occurring in the operation of the desorption unit. For example in the splitless mode of operation at low flows, the ball in the rotameter normally falls down to zero upon the initial injection of the desorption tube syringe into the GC injection port, but will eventually rise back up to its set value. This is due to the initial surge of backpressure from the gas pressure in the GC injection port. If the rotameter continues to read zero, it indicates that the needle is probably clogged. If after desorption has begun, the flow meter ball continues to slowly fall to zero, it indicates that the column is beginning to plug. This is most likely due to the formation of an ice plug at the front of the column if cryo-cooling is used. See the troubleshooting section for details of how to eliminate this problem.

## 4 - Desorption Unit Description

Standard conditions	1 atm. @ 70 deg. F	
Metering Temperature	70 deg. F	
Metering Pressure	14.70 PSI (1 atm)	
Metered Fluid	Air	
<b>Scale Readings</b>	<b>Glass Ball Flow (Black)</b>	<b>Carboloy Ball Flow (Silver)</b>
150.0	29.3 ml/min	130 ml/min
140.0	24.9	112
130.0	22.2	101
120.0	20.8	91
110.0	17.7	78
100.0	14.1	67
90.0	12.2	58
80.0	10.9	50
70.0	8.8	40
60.0	7.0	34
50.0	5.7	30
40.0	4.9	25
30.0	4.0	20
20.0	3.1	15
10.0	1.9	9

Figure 4-5 - Flow Meter Calibration Data

### **Carrier/Purge Pressure Gauge**

A 0-75 psi pressure gauge is contained inside the Desorption Unit (Figure 4-1) to measure carrier gas pressure as it goes through the Desorption Unit. This pressure (psi) is displayed in the Status Window of the Thermal Desorption Software. This reading can be used in conjunction with the pressure gauge on the GC injection port to regulate the operation of the system as well as troubleshoot when problems are occurring such as leaking seals, plugged needles and bad septa in the GC. The pressure gauge in the Desorption Unit measures the carrier gas pressure at the top of the desorption tube. The pressure gauge on the GC measures the pressure in the injection port and upon injection the pressure at the bottom the desorption tube. With experience, the user should develop the ability to monitor system performance using the pressure reading and rotameter. See the troubleshooting section for more information.

After the desorption tube and needle have been injected into the GC, the back pressure on the desorption tube pressure gauge should exceed 1 psi (the limit adjustable in the Configuration dialog box of the Thermal Desorption Software). If it does not, it is an indication that a gas leak exists either in the injection port of the GC or, more likely at one of the seals of the desorption tube. If this threshold is not exceeded, the desorption block heaters will not close and an error will be triggered in the Thermal Desorption Software. This permits the user to retrieve samples before the heater blocks begin desorbing the volatiles into a leaking system.

### **Flexible Connecting Line**

A 1/8" diameter coiled Teflon™ gas line provides the flow path of carrier gas from the pressure gauge inside the Desorption Unit to the top of the desorption connector tube. It permits the auto-injector to move up and down while still providing carrier gas through the desorption tube.

### **Connecting Tube**

The connecting tube is machined from stainless steel, and provides the fitting into which the desorption tubes are attached, as well as an 1/8" Swagelok™ fitting at the top for attachment to the flexible connecting line. Both a graphite seal with a metal insert and a graphitized Vespel™ seal must be used to provide a leak free connection to the desorption tube. As always, the seals must be inserted so that the end of the desorption tube contacts the stronger Vespel™ seal, with the graphite material between the connecting tube and the Vespel™ piece. Reversing these seals will result in improper sealing and disintegration of the soft graphite piece. See Figure 4-9. The harder Vespel™ material provides a more durable sealing surface, however more torque is required to produce an adequate seal. It may be necessary to use a small pair of pliers to turn the tube an additional 1/16 to 1/8 turn beyond finger tight to obtain a leak-free seal. Overtightening of the desorption tube should be avoided, however, because it leads to excessive wear and cracking of the seals.

The connecting tube can be removed and packed with a suitable adsorbent material to provide a final conditioning step for the carrier gas. This is recommended particularly for those who use the direct thermal extraction technique on powdery samples. Once packed, the connecting tube can be periodically cleaned in the SIS Conditioning Oven by replacing one of the tube conditioning handles with the connecting tube, and inserting it in the oven. The best adsorbent materials for this purpose are Carbosieve™ SIII and Carboxen™ 569. These materials are spherical in shape, and present less backpressure when packed in the connecting tube. They are also both quite aggressive, and will provide many hours of continuous use between conditionings. When reattaching the Connecting Tube, take care to leave a 3/16" space between the bottom of the Swagelok fitting and the mounting block.

	<b>Graphite</b>	<b>Graphitized Vespel™</b>	
<b>Abrasive Resistance</b>	P	Ex	
<b>Heat Resistance</b>	Ex+	Ex	P - Poor
<b>Maximum Temperature</b>	450°C	350°C	EX - Excellent
<b>Sealing Properties</b>	EX	G	G - Good
<b>Ease of Removal</b>	G	EX	

**Figure 4-6 - Properties of Various Materials Used in Sealing Washers**

### ***Air Pressure Switch***

There is a pressure switch inside the Desorption Unit to detect the presence of compressed air pressure. An error will be triggered in the Thermal Desorption Software if this switch indicates little or no pressure.

### ***Warning Indicators***

A warning buzzer and light are mounted on the Desorption Unit. The purpose of these warning devices is to notify the user before the injection process begins. The buzzer will begin to sound and the warning light will turn on three seconds before the injection process begins. Both of these devices must be operative at all times. In no case should they be deactivated by the user. In the event of the failure of either of these warning devices, the system should be returned to the SIS for service.

**WARNING** - When the warning buzzer and light are ON, remove hands and other objects from the path of the injection needle.

The buzzer/light are also used for status messages:

- **One short beep** is given when the Electronics Console is turned on.
- **Two short beeps** are given if the Electronics Console loses communications with the Thermal Desorption Software.



#### 4 - Desorption Unit Description

<b>Part #</b>	<b>Description</b>
786005	GLT Desorption Tube, empty, 3.0mm I.D.
786001	Silco-Coated Desorption Tube, empty, 3.0mm I.D.
786002	Silco-Coated Desorption Tube, empty, 4.0mm I.D.
781006	Cap, Desorption Tube, Solid
781007	Cap, Desorption Tube, Drilled 0.040" Hole
786035	Needle on Cap, 35mm L x 0.63 O.D. x 0.32 I.D., side hole
786135	Silco-Coated Needle on Cap, 35mm L x 0.63 O.D. x 0.32 I.D., side hole
781004	Teflon Seals for Caps and Needles, pkg of 10 .210" O.D. x .120" I.D. x .0625" thick
781015	Graphite Top Sealing Washer w/Metal Insert (for TD-4) .210" O.D. x .060" I.D. x .0625" thick
781016	Graphite Needle Sealing Washer .210" O.D. x .040" I.D. x .0625" thick
781017	Graphitized Vespel™ Top Sealing Washer (for TD-4) .210" O.D. x .060" I.D. x .0625" thick
781018	Graphitized Vespel™ Needle Sealing Washer .210" O.D. x .040" I.D. x .0625" thick
786017	Vespel Seal with Cartridge
786910	Seal Removal Tool
781070	High Temp. Green Septa for Caps, pkg of 50
781010	Desorption Tube Hose Connector
781011	Desorption Tube to 1/4" Tube Connector
781012	Desorption Tube to 1/8" Swagelok Connector
781019	Desorption Tube to 1/4" Swagelok Connector
<b>Desorption Tube Cleaning Systems</b>	
781051A	Desorption Tube Conditioning Oven & Controller, for 6 tubes simultaneously, 6 ball rotameters, 6 desorption tube handles and 2 needle handles, Temperature Programmable Controller
781013	Desorption Tube Handle
781014	Desorption Needle Handle

**Figure 4-7- Accessories for Thermal Desorption System**

# 5. Desorption Tubes

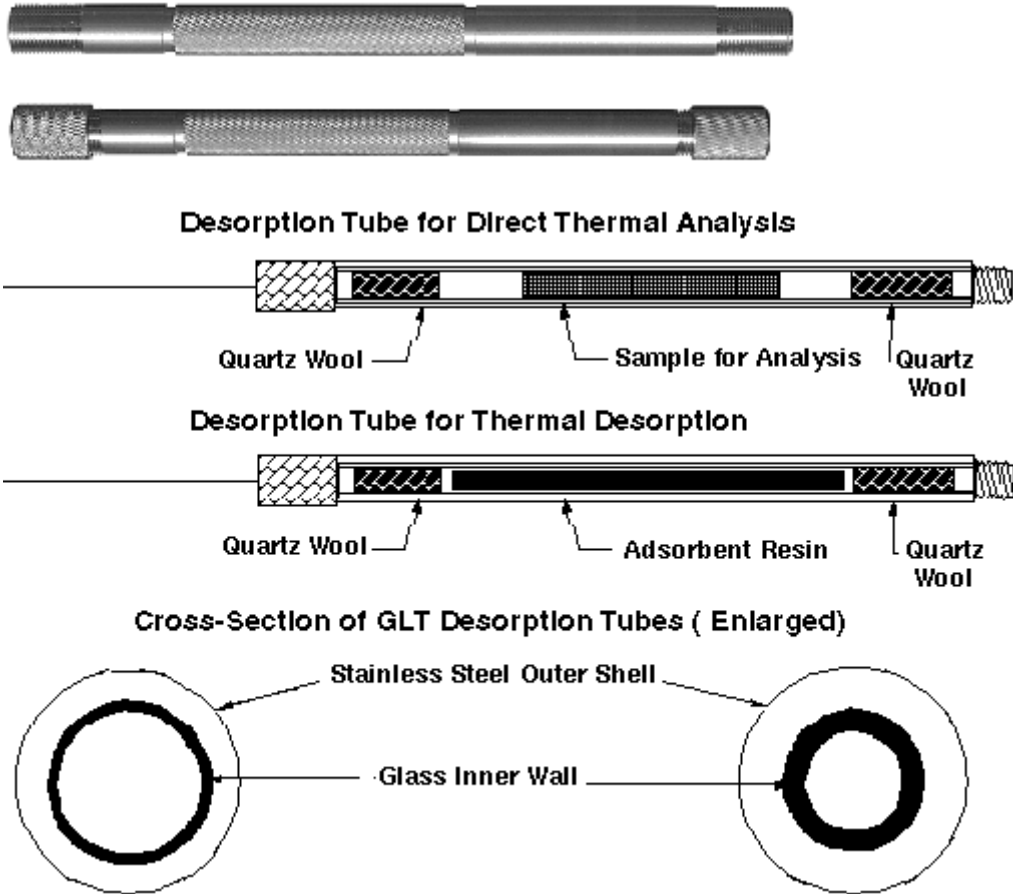

Figure 5-1 – Photos and diagrams of desorption (sample) tubes.

## **Overview**

This chapter details the composition and use of desorption tubes for holding samples.

Glass-lined stainless steel (GLT) (3mm I.D.) and silco-coated (3mm and 4mm I.D.) desorption tubes are available (Figure 5-1). Each tube is 4.0" long by 1/4" outside diameter and is threaded on both ends. After conditioning and sample loading, the ends of the tubes are fitted with stainless steel caps with Teflon™ seals to maintain the integrity of the medium and sample. The threads on the desorption tube also provide the means of attaching the desorption tubes to the connecting tube and the needle.

Samples to be analyzed are collected on the glass lined stainless steel (GLT) desorption tubes that have been previously packed with a porous polymer such as Tenax™ (TA) or activated charcoal and conditioned. Solid samples can also be placed directly in the desorption tubes and thermally extracted without the use of adsorbents. The glass lining provides an inert surface for samples and can be silylated if so desired. After sample collection the desorption tubes are capped with stainless steel caps with Teflon™ liners to maintain sample integrity during storage and transportation. When ready for analysis, the caps are removed and a stainless steel needle is attached to the desorption tube. The collected sample can then be desorbed directly into the injection port of the gas chromatograph.

### Features

- Strong stainless steel (S.S.) outer shell
- Inert glass or silco-coated lining
- Stainless steel (S.S.) caps with seals to prevent contamination
- Available in two inside diameters, 3mm and 4mm I.D
- Two methods of analysis
- Thermal Desorption from adsorbent resins
- Direct Thermal Extraction for solid samples

## ***Needles for Desorption Tubes***

Needles for desorption tubes are available in a wide variety of sizes and shapes. Needles are permanently silver soldered to the caps to provide a strong leak-free assembly. Depending on the application and on the type of injection system of the GC, a suitable length of needle will need to be used. Needle lengths between 25 mm and 60 mm are available. The shorter the needle, the longer the expected life of the needle. Four styles of needles are available, including a special needle for the Jade™ injection system.

**NOTE: Side hole needles are recommended for most applications due to the elimination of coring of the septa when these needles are used. The 35 mm side hole needle is recommended for most applications. Refer to your current SIS catalog for the various styles of needles that are available for use with the TD-5.**

## ***Cleaning of Desorption Tubes***

For a complete detailed description of the conditioning oven and cleaning of desorption tube see the conditioning oven section of this manual.

Desorption Tube preparation is usually a multi step process including: (1) washing, (2) silylating, (3) rinsing, (4) drying, (5) packing, (6) conditioning, (7) sealing, (8) storage

All desorption tubes should be thoroughly cleaned by water rinsing followed by an acetone rinse and dried in an oven at 250°C. Cleaning by additional solvents may be required depending on the applications of the user. It is important to remove all solvent residues by thoroughly baking out the tubes.

Treatment with a suitable silylation reagent such as Dimethyldichlorosilane (DMDCS) is optional depending on the nature of the components being analyzed and the requirements of the user. The procedures of the manufacturer should be followed including thorough rinsing and baking out of the prepared tubes.

**Note: Suitable safety precautions must be taken when working with solvents.**

## ***Packing Desorption Tubes***

Samples are collected on sample tubes packed with a porous polymer resin such as, 2, 6-diphenyl-p-phenyleneoxide sold under the trademark TENAX™ TA or carbon molecular sieve material sold under the trademark CARBOXEN™. There are many other adsorbent materials which function well and are available from many manufacturers including S.I.S. For help in determining the proper adsorbent for your application, visit the S.I.S. website at [www.sisweb.com](http://www.sisweb.com).

The desorption sample tubes are usually packed with approximately 20-200 mgs of adsorbent. The amount of adsorbent used depends on the users' requirements. The ends of the tubes are plugged with approximately 1cm of silanized glass wool on each end to hold the adsorbent in place.

As an alternative, the sample tubes can be packed with the actual materials to be analyzed for controlled direct thermal analysis of residual components such as packaging materials, construction materials, fibers, paint chips, etc.

## ***Conditioning Thermal Desorption Tubes***

In order to prepare the adsorbent packed desorption tubes for the collection of samples, the tubes must be conditioned to remove all foreign materials including water vapor. The following procedure or a suitable version of this method should be used to condition the desorption tubes. The maximum temperature will be determined by the properties of the adsorbent material used in the desorption tubes.

## 5 - Desorption Tubes

The sample tubes containing the adsorbent are heated from ambient temperature to 300°C at a rate of 4°/min while purging with nitrogen or helium at a flow rate of 2 to 20 ml/min. The tubes are held at the upper temperature limit for not less than four hours for optimum conditioning under continuous flow. After conditioning and cooling under constant flow, the tubes are immediately capped on both ends with stainless steel caps with appropriate liners that have also been conditioned. The sample tubes are then fitted with identification tags. Tubes prepared in this manner exhibit excellent adsorptive capacity and contain no organic background when analyzed by GC/MS.

The stainless steel caps with liners can easily be conditioned by baking out in a GC oven.

### ***Desorption Tube Conditioning Oven***

For the conditioning of the desorption tubes, a Desorption Tube Conditioning system is available from S.I.S. which includes a Conditioning Oven and Controller for conditioning 6 tubes simultaneously. The self contained system includes 6 rotameters with flow ranges of 0 to 50 ml/min, 6 desorption tube handles, two needle handles and a digital temperature programmable controller. (See Section 10) The Controller system with program memory permits the temperature program ramp described above to proceed unattended. A procedure of up to 6 steps with various ramp cycles and hold times can be programmed into the controller.

The desorption tube Conditioning Oven can also be used to clean the desorption tube needles. Two needle handles are included with each unit. The needles are normally conditioned at 300°C with gas flow.

# 6. Software Operation

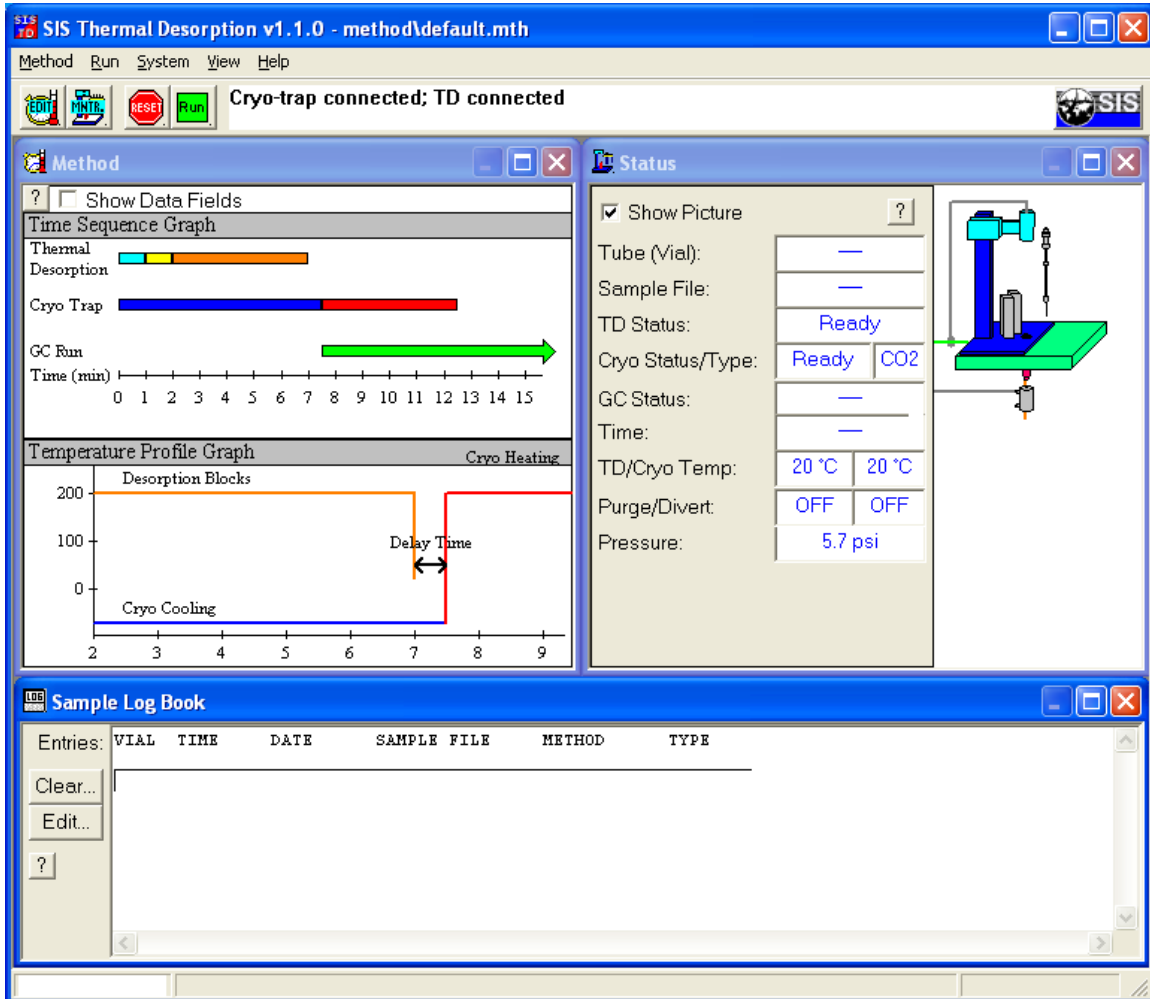

Figure 6-1 – Thermal Desorption Software window

### **Overview**

This section details the Thermal Desorption Software and its use in configuring, running, and monitoring the Thermal Desorption Unit. See Chapter 1 for a background on the Thermal Desorption Software.

### **Getting Started**

Before you begin using the TD-5, make sure that it has been properly installed. This pertains not only to the Desorption Unit, Electronics Console and Cryo-Trap, but also to the Thermal Desorption Software. Installation by a technician trained by SIS is recommended, and certain warranty provisions may be void unless the installation is performed by certified personnel. Installation by an authorized agent of SIS is always accompanied by initial training in the use of the system using customer samples when possible. This is the best way to be sure that your system is correctly installed.

At a minimum, verify that carrier gas, compressed air, electrical power, and if applicable, cryogenic fluid have been correctly connected and supplies are adequate.

Verify that the Desorption Unit is in place over the GC inlet, and that the centering septum nut is present.

It is also recommended to READ THIS MANUAL THOROUGHLY before using the system.

### **System Startup**

First, turn on the power to the Electronics Console.

If the Thermal Desorption Software is running in integrated mode (integrated with your GC data system), the Thermal Desorption Software will open automatically when the GC data system is opened. If not, start the Thermal Desorption Software manually as shown in Figure 3-9.

When the Thermal Desorption software is started, it will attempt to communicate with the Electronics Console. Any error messages will be displayed at this time.

Once the system has started and initialized, a method can be created, or samples may be run using a previously stored method.

### **Thermal Desorption Methods**

Parameter settings for one or more thermal desorption runs are contained in a Thermal Desorption Method, which can be saved as file of extension “.mth”. You can have multiple methods, which can be loaded, saved, and edited as needed using the Thermal Desorption Software.

## 6 - Software Operation

Furthermore, if the Thermal Desorption Software is used in integrated mode, the Thermal Desorption Method will be saved (and linked to) the GC method in your GC data system so that appropriate thermal desorption parameters will be loaded automatically when a GC method is loaded in your GC data system.

Creating a thermal desorption method is a matter of modifying an existing one to suit the current analysis. A default method is loaded when the Thermal Desorption Software is started in standalone mode or if a GC method without thermal desorption settings is loaded in integrated mode.

### Method Edit View

The thermal desorption method settings can be edited from the **Method Edit View** of the **Method Window**, which is accessible from the “**View | Method Edit View**” menu item or the  button on the toolbar.

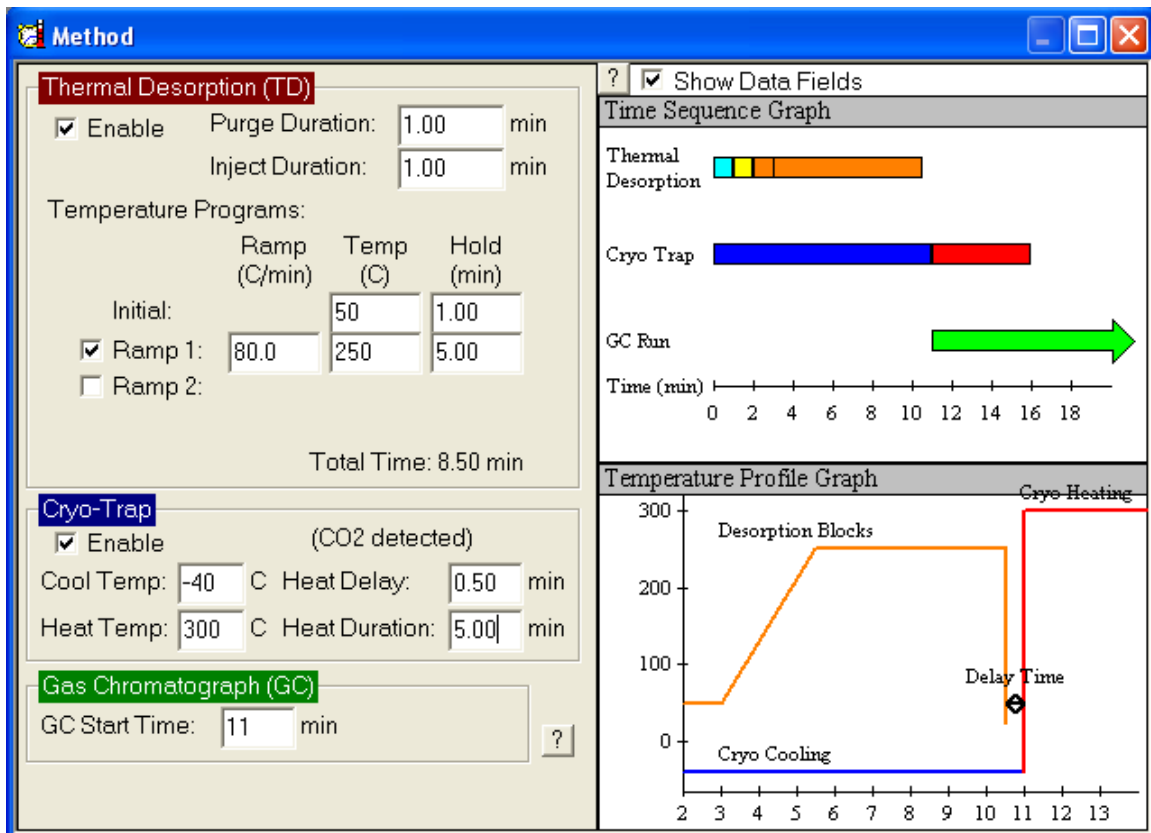

Figure 6-2 – Thermal Desorption Method Window

The Desorption Unit (TD) and Cryo-Trap can be independently enabled or disabled from in the method by checking the “*Use TD*” or “*Use Cryo*” boxes. An example of a method that would not use the Cryo-Trap is the thermal extraction of high-boiling components from a soil sample (e.g. PCB’s or Polynuclear Aromatic Hydrocarbons). In this case,



## 6 - Software Operation

materials that would be focused on the column cryogenically might only interfere with the analysis. Likewise, the Cryo-Trap may be used with the Desorption Unit disabled and removed from the GC injection port in order to do focusing static headspace injections.

The main parameters for the thermal desorption are the Purge, Inject, and Desorb times and the temperature settings for the desorption heater and cryo-trap. Other parameters include the GC start time and Cryo-Trap heat delay and duration. Adjustable parameters are explained briefly below:

**Purge:** This is the time allowed for gas to purge across the desorption tube before the needle is lowered into the GC inlet. This allows for a volume of carrier gas to remove oxygen, excess water, or other unwanted volatile materials that may be resident in the tube. **The default setting for the purge gas time is one minute.** Note that the retention of some analytes may be affected by this purge, and the use of a more appropriate trapping resin may be indicated if sample is lost due to this small volume. Purge gas flow is regulated by a mass flow controller mounted on the front of the Desorption Unit. The flow should be adjusted to provide adequate carrier to sustain Total Flow for the highest split to be used. The setting is best made by adjusting the flow controller during the Inject period, after the carrier has been diverted (see below).

**Inject:** The inject period begins when the needle is lowered into the GC inlet. A drop in inlet pressure is normal as the septum is punctured; however, re-pressurization should follow rapidly as the desorption purge flow and normal GC carrier are both directed into the inlet. The dual flow lasts for a preset time after which the carrier gas regulated by the GC's pressure control feature is diverted to pass through the Desorption Unit. The **default value of 20 seconds for the dual flow period** is changeable from the “**System | Configure... | Limits**” and changing GC Gas Divert Time.. In this way, the pressure and flow control are handled by the GC for maximum consistency. Although an **inject time setting of one minute is supplied in the default method**, it should be set in conjunction with the Purge Gas flow to allow the injection port pressure to equilibrate and the proper split flow to be reached before the time expires. At least once for each method, it is advisable to check the split flow after the carrier gas has diverted, and adjust the time if necessary (See Figure 4). At the end of the Inject period, a pressure reading from the Desorption Unit is compared to the **Minimum Pressure to Run** set-point in “**System | Configure... | Limits.**” If the minimum pressure is not met a leak is assumed, the sample is terminated.

**WARNING: SPLITLESS INJECTION IS NOT RECOMMENDED.** The low flow rate associated with most splitless injections does not provide an efficient transfer of material from the desorption tube to the column. Most chromatographs will yield

## 6 - Software Operation

inconsistent results with splitless injection due to difficulty regulating the inlet flow through the desorption unit in this mode.

**Desorb:** When the Inject time expires, the heater blocks close around the desorption tube and remain closed for the time specified here. The Desorb duration cannot be edited from the Time Settings window. It is affected by temperature ramp rates and hold times specified in the Temperature Settings window, and is calculated automatically. **The value supplied in the default method is five minutes.**

### Cryo Heat Delay:

This provides a short equilibration period after the desorption needle is removed from the inlet. During this time, the cryo-trap is held in cooling mode to prevent pressure fluctuations from affecting chromatography. The default value for the cryo heat delay is thirty seconds. At the end of the delay, the cryo-trap is ballistically heated to release the focused analytes instantaneously, much like a liquid injection.

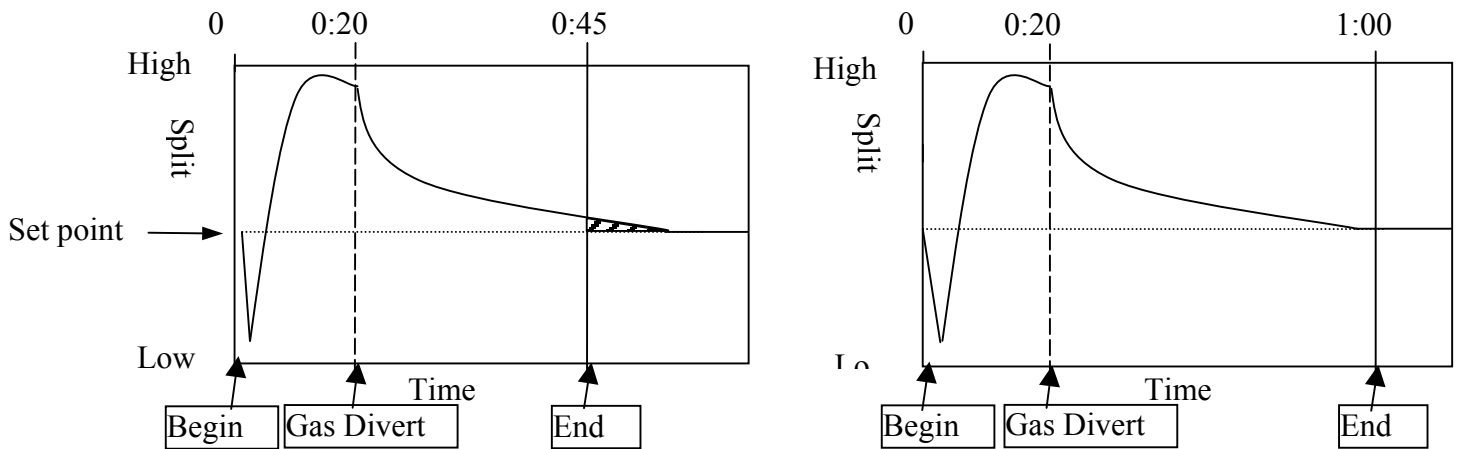

**Injection time incorrectly set. Insufficient time allowed for split flow to equilibrate at the set point.**

**Injection time correctly set. The split flow has been allowed to stabilize**

Figure 6-3 - Setting the Inject Time Parameter

### Cryo Heat Duration:

This setting controls the length of time that the cryo-trap is heated. Most volatile materials should be released in the first few seconds of heating. Keeping the cryo-trap heater on for long durations may shorten its life. The default setting of five minutes is recommended for most analyses.

### GC Start Time:

The time specified here is relative to the beginning of the Purge time. The GC may be started at any time beginning with the activation of the desorption Purge. Normally the GC Start time is set to coincide with the

start of the cryo-trap heating by using the sum of the Purge, Inject, Desorb, and Heat Delay times. This provides chromatographic results that most closely match those obtained by liquid injection. Starting the GC early may be useful in method development (particularly when choosing a cryo-trap cooling temperature) since compounds breaking through a cryo-trap that is too warm may go unnoticed unless the data system has been started. Early GC start times may also be used to take advantage of functions such as inlet pressure programming that are controlled from the GC time base.

### **Desorption Temperatures and Ramp Rates:**

For isothermal desorption (recommended for most adsorbent trap methods) the only entries necessary are the initial temperature and desorption duration. For ramped desorption (recommended for Direct Thermal Extraction) one or more segments of the temperature program are selected for use by checking the box next to the segment label (Ramp 1, Ramp 2, etc.). When selected, heating rate ( $^{\circ}\text{C}/\text{minute}$ ), target temperature ( $^{\circ}\text{C}$ ) and hold time (minutes) for each segment may be entered. The maximum controlled heating rate is  $100\text{ }^{\circ}\text{C}/\text{minute}$ . A heating rate value of  $0^{\circ}\text{C}$  will result in the ballistic heating of the sample. Total desorption time is calculated automatically.

### **Cryo-trap Temperatures:**

Cryo-trap cooling temperature may be set between ambient temperature and  $-70^{\circ}\text{C}$  for liquid  $\text{CO}_2$  use or between ambient and  $-180\text{ }^{\circ}\text{C}$  for liquid nitrogen. Cooling temperature should be set below the freezing point of the most volatile compound being analyzed. When using liquid  $\text{CO}_2$ , trapping efficiency may be enhanced by using thicker film guard columns. When using liquid nitrogen, trapping temperatures often go below the glass transition point of the polysiloxane bonded phases ( $\sim -60$  to  $-70\text{ }^{\circ}\text{C}$ ). Therefore the use of a bonded phase offers no advantage in terms of trapping efficiency, and may actually be detrimental to the column due to the rapid temperature changes. Deactivated fused silica guard columns are recommended for use with liquid nitrogen. For either liquid nitrogen or liquid  $\text{CO}_2$ , the use of a wide bore capillary guard column will increase the trapping capacity and minimize the chance of an ice plug forming in the trap. The cryo-trap heating temperature should be set slightly higher than the GC inlet. Keeping each successive stage of the chromatographic system hotter than the last helps to keep the system clean and prevent carryover.

### **Saving settings**

When modifying an thermal desorption method, it is important to remember to save the changed settings by selecting “**Method | Save Method**” or “**Method | Save Method As**” from the menu bar or (in integrated mode) by saving the entire method from the GC data system. If the setting changes are not saved, the prior settings will be restored the next time the method is loaded. As a reminder, the text “*METHOD NOT SAVED*” appears in the

## 6 - Software Operation

lower right-hand corner of the Thermal Desorption Software whenever a setting change is made. Setting changes can be made at any time, even in the middle of a run. Although not recommended for normal operation, this flexibility can assist in method development. Any changes that are made during a run are recorded in the log book; however, changes must be saved if successive runs in a sequence are to use the new settings.

### Importing settings

In integrated mode, it can be useful to import thermal desorption settings from one GC method into another. This is made possible by the “**Method | Import Method...**” menu item.

### Running a Single Sample

Once the data system and thermal desorption parameters have been set, a single sample may be run from the data system in the same way a single sample would be run using a liquid autosampler.

**In standalone mode**, select the “**Run | Run Sample...**” menu item or click the  button. Then click “**Start Run**”.

**In integrated mode using ChemStation** the following procedure is used. From the Instrument Control or Run Control window, select **Method | Run** to activate the Start Run window. Edit sample information and click the **Run Method** button in the Start Run window. The entire data system method, including thermal desorption settings, will be executed when the GC becomes ready.

**Terminating a run:** If for any reason the sample must be aborted or stopped during the run, do so by selecting the “**Run | Reset Controller...**” menu item or clicking the  button on the toolbar.

The thermal desorption software contains error handling protocols that will assure that the GC oven temperature program is run if there is an error following the desorption blocks having been closed. Stopping the GC run from ChemStation may result in desorbed analytes remaining on the column into the next run.

### Status Window

During the run, the actual temperatures, pressures, and states will be displayed in the **Status Window** (Figure 6-4). This window also includes an animated graphical representation of the Desorption Unit. This window is displayed by selecting the Run Monitoring View (“**View | Run Monitoring View**” from the menu or the  button).

## 6 - Software Operation

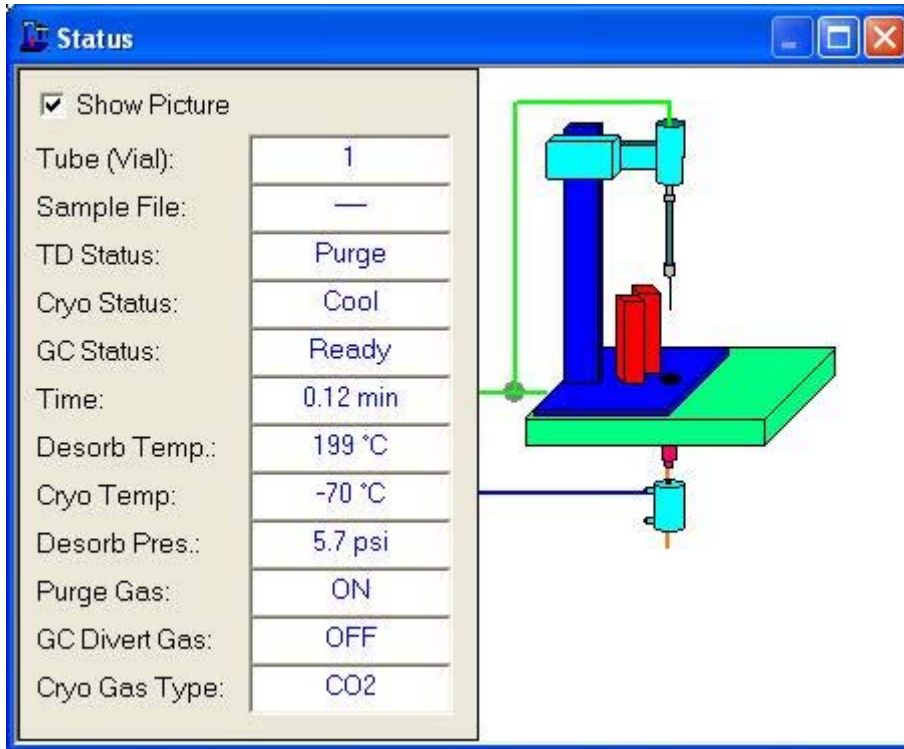

Figure 6-4 - Status Window

### The Sample Log Book

The Thermal Desorption Software has extensive error and status logging functions. The **Sample Log Book** (Figure 6-5) keeps track of all errors and method changes that occur during a run or sequence. It is an excellent tool to use for diagnosing problems, verifying that sequences have run completely, and tracking method changes. The Sample Log Book can be accessed by clicking selecting the “View | Run Monitoring View” menu

item or clicking the  button on the toolbar.

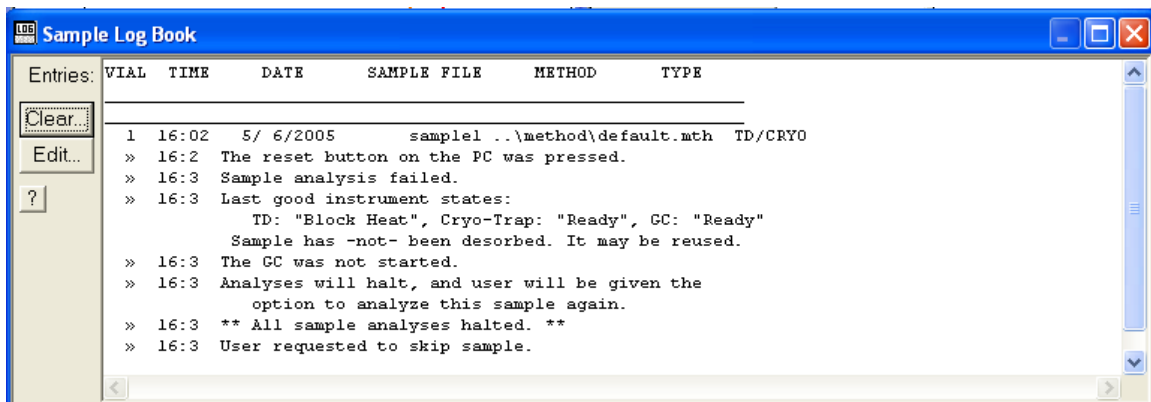

Figure 6-5 - Sample Log Book

## 6 - Software Operation

An entry in the Log Book is created every time the data system begins a run. The initial entry consists of one line of text and contains the Vial number, Time, Date, Data file name, Method name and the names of active instruments in the method being used (e.g., cryo-trap or TD). Most often, only one more entry is made for each sample when the data acquisition is complete, and it contains the time and a message confirming the successful completion of the sample. Entries for different samples are separated by a solid line. When an error or a method change occurs, the event is logged with the time, the error or change, and sometimes extra information about the sample.

Sample Log Book data is stored in a file named **default.log** in the C:\Program Files\SIS\TD\logs directory. The Sample Log Book may be opened in Notepad by clicking the “Edit...” button on the Sample Log Book. Periodically, the Sample Log Book should be archived (opened in Notepad and saved with a different name) and cleared via the “Clear...” button.

### ***Online Help***

Additional details can be found from the online help (**Help** menu) or by clicking the “?” buttons.



# **7. Standard Operating Parameters**



### **Overview**

The TD-5 can be installed on instruments from a variety of manufacturers. These instruments exhibit a wide spectrum of flow system designs which when combined with the variety of injection techniques—such as direct injection, split, splitless, and cool-on-column—and a variety of types of analysis result in many different ways to operate the TD-5. Considerable variation in the configuration of setup is anticipated from one instrument to another. No one methodology can be outlined to suit all situations, and appropriate methodology must be developed. The following methodology is intended to be a general guide that can be modified to suit the analyst's needs.

### **GC Carrier Flow**

When using the TD-5, GC carrier flow through the column is redirected through the Desorption Unit. This is discussed in previously. An understanding of your particular GC design is important in determining optimal parameters.

Care must be used in operating the thermal desorption system on instruments such as the Agilent (HP) 5890 series GC's, which operate with back pressure regulation on the injection port. In these instruments, any gas flow which exceeds the capacity of the column at the preset pressure will be diverted out of the split vent. During desorption the only flow into the GC injection port is through the desorption tube. The flow can be accurately regulated to provide either split or splitless injection. Figure 7-1 shows the flow schematic for the desorption system when using the carrier gas solenoid valve assembly part #7859993. The deactivated mode represents standard GC carrier operation. In the activated mode, during injection and desorption, the carrier flow is directed through the desorption system.

### **GC Requirements**

**GC Column Trapping:** The GC column should be capable of being cooled to subambient temperatures of between 0°C and -180°C. This is required to permit the desorbed samples to be concentrated and collected in a narrow band at the front of the GC column. This can be accomplished by using a GC equipped with subambient cooling capability (liquid nitrogen or CO<sub>2</sub>) or with the Cryo-Trap Accessory. Temperature programming is required to enable the system to be heated for the subsequent analysis by the GC and detector system. Some analysis may be accomplished by collecting samples at room temperature using thick film megabore capillary columns (such as the J&W DB-624 column) or packed GC columns.

**Column:** The specific GC column and temperature program employed will be dependent on the specific compounds being analyzed. Generally, a nonpolar stationary phase (e.g. DB1, DB-5, SE-30, OV-1) temperature programmed from -30°C to 250°C at 4-10°/minute will be suitable. Capillary column dimensions of 0.20mm to 0.53 I.D. and 25 to 60 meters long are generally appropriate although other I.D.'s and lengths may be

## 7 - Standard Operating Parameters

sufficient in many cases. The system can also be used with packed columns, however the Cryo-Trap can only be used with capillary columns.

Often a deactivated fused silica precolumn of approximately one meter in length by 0.53 mm I.D. is used at the injection port end of the GC column. The precolumn will help prevent the plugging of the system by water, which is present in most samples and which is desorbed into the GC. The larger I.D. of this precolumn permits a larger surface area for the sample to collect with less chance of plugging by water vapor condensing on its surface. Samples with high water content should be avoided when possible.

Techniques and methods will vary from user to user and depending on the set-up, but listed below are several which may be used as guidelines in thermal desorption analysis.

### ***Splitless Operation with the Agilent (HP) 5890 Split/Splitless Injection System.***

**Note:** The following applies only to the Agilent HP 5890. **Splitless mode is not recommended on an Agilent HP 6890** (see note in next section).

The correct carrier gas valves should be in place before proceeding. With the tube and needle assembly withdrawn from the GC injection port, the GC carrier gas flow is set by adjusting the injection port head pressure to provide the required column flow. The total flow is adjusted to the level where no flow is evident at the split outlet. This will provide for splitless injection and running of the system.

When the desorption tube and needle are installed, the carrier flow through the desorption tube is adjusted to 1 to 3 ml/min. with the flow controller on top of the Desorption Unit. The desorption tube and needle are injected into the GC injection port. Upon initial injection a drop in flow through the desorption tube is seen on the rotameter and the head pressure observed at the pressure gauge on the GC injection port will drop. This is caused by the injection port momentarily depressurizing.

After a short time (5-10 seconds) the flow will return to its normal level. If the head pressure at the front of the GC column falls to zero and remains there, it is an indication of a leak at the seal of the injection needle or a leaking septum. The column head pressure should normally return to some positive value. At this point the normal carrier gas flow through the GC is turned off, and the only flow through the GC column is provided by the desorption system. The flow is adjusted to the point where no flow is detected at the split vent but where sufficient flow is provided to elute the desorbed material from the desorption tube.

After the flow is adjusted to its proper level the sample can be desorbed into the GC. Desorption times of 5.0 to 15 minutes are sufficient for most samples. Samples are collected at the front of the GC column which has been lowered to sub-ambient temperatures.

After desorption is complete, the GC carrier gas is turned back on, and the desorption tube and associated needle are removed from the injection port. The GC is returned to normal operation with the preset GC carrier flow and head pressure. GC temperature programming can begin for the analysis of the desorbed components which have been trapped on the front of the column.

### ***Split Operation with the Agilent (HP) 6890/5890 Series GC's***

**Note on Agilent HP 6890:** The TD-5 is designed to work on an Agilent 6890 in the "split" mode of operation. Other GC methods such as splitless, pulsed split and pulsed splitless may result in the lack of flow of carrier gas through the SIS Desorption Unit during desorption and may shut down the GC.

## 7 - Standard Operating Parameters

The operation of the Agilent 6890 and 5890 series GC's for split operation is conducted much the same as described above except that the total flow through the desorption tube is increased to the level where the desired split is achieved at the GC split vent. The desorption blocks are not closed until all the flows are stabilized and the desired split flow is measured at the split vent.

### ***Split or Splitless Mode Operation with the Varian 3800 GC with Split/Splitless Injector***

When the desorption tube and needle are installed, the carrier flow through the desorption tube is adjusted to 1 to 10 ml/min. (depending on the diameter and flow capacity of the GC column) with the flow controller on top of the Desorption Unit. The desorption tube and needle are injected into the GC injection port. Upon initial injection a drop in flow through the desorption tube is seen on the flow meter on the desorption unit and the head pressure observed at pressure gauge on the GC injection port may drop. This is caused by the injection port momentarily depressurizing upon injection. After a short time (5-10 seconds) the flow will return to its normal level. If the head pressure at the front of the GC column falls to zero and remains there, it is an indication of a leak at the seal of the injection needle or a leaking septum. The column head pressure should normally return to some positive value. For the split mode of operation, the flow would be adjusted for the proper split ratio. The desorption cycle is initiated. Desorption times of 5.0 to 15 minutes are sufficient for most samples. Samples are collected at the front of the GC column which has been lowered to subambient temperatures.

After desorption is complete, the desorption tube and associated needle are removed from the injection port. The GC is returned to normal operation with the preset GC carrier flow and head pressure. GC temperature programming can begin for the analysis of the desorbed components which have been trapped on the front of the column.

**GC injector trigger:** The GC injector trigger should be disconnected or the force of the desorption tube will start the GC temperature run. The remote start cable will start the GC temperature run after the desorption run is completed.

### ***Direct Thermal Extraction***

In the **Direct Thermal Extraction (DTE)** technique, the sample to be analyzed is placed directly in the desorption tube for subsequent analysis of the volatile and semi-volatile organics present. This technique proves useful for materials such as spices, paints, fibers and plastics. It is important to avoid samples with high water content since the water vapor will be desorbed into the GC injection port and will tend to form a plug at the front of the column, restricting carrier flow. This problem can be reduced by:

- (1) using small samples
- (2) using a larger diameter precolumn (megabore column)
- (3) desorbing at low temperatures (below 70°C)
- (4) analyzing dry compounds

## 7 - Standard Operating Parameters

- (5) using a megabore or packed GC column

Any of the techniques normally used in GC analysis including split, splitless, direct injection, etc. can be used for DTE analysis. A wide range of temperatures can be used to drive off the compounds of interest. It is possible to desorb the same sample several times, each time at a higher temperature, to enable a fractionation of the sample components for subsequent analysis. The use of temperature ramping is recommended when using the DTE techniques. (See application note #60 at <http://www.sisweb.com/sptd> .)

### ***Suggested Standard SPLIT/SPLITLESS INJECTION Protocol***

Temperatures, times, and other parameters given are only guidelines and should be optimized for each analytical method.

#### Setting Up the Desorption Unit

- (1) Turn on Main Power on the Desorption System
- (2) Thread the needle on to the desorption tube. Ensure the graphitized Vespel needle washer is inside the needle body to ensure no leakage. Make sure the syringe is reasonably straight.
- (3) Thread the desorption tube (with needle attached) onto the Injector. A Vespel seal inside the Injector ensures no leaks. Hand-tighten by placing as many fingers as you can on the tube and tighten. Insert graphite & graphitized Vespel™ seals into needle cap.
- (4) Attach needle to sample tube
- (5) Turn carrier gas on
- (6) Open the flow controller valve  $\frac{3}{4}$  open or more by turning the knob on the top of Desorption Unit
- (7) Flow is monitored by the rotameter
- (8) Flush/Purge system for 2-3 minutes to eliminate oxygen

### ***Thermal Desorption and Sample Analysis***

**NOTE: This method is for reference only and will need to be modified for your particular analysis.**

#### Setting Typical GC/MS Parameters

- (1) Scan mass from 35 to 350 at 2 scans/sec
- (2) Injection Port Temperature: 260° C
- (3) Detector/GC transfer line: 280° C
- (4) GC column temperature: -40°C or use the Cryo-Trap
- (5) Allow parameters to equilibrate

Thermal Desorption Settings:

## 7 - Standard Operating Parameters

### Time Settings:

Purge Gas Time:	1 minute
Inject Time:	1 minute
Desorb Time:	5 minutes
Cryo-Heat Delay Start:	30 seconds

### Temperature Settings:

Temperature:	200°C (no ramps)
--------------	------------------

\*Note: If temperature ramp is desired, enter appropriate Begin, Rate, and End values.

### Cryo-Trap Temperature Settings:

Cooling:	-40°C
Heating:	260 °C

- (1) Verify that GC flow settings are correct. For systems with EPC, set split flows normally. If the Cryo-Trap accessory is used, ensure it is enabled in the thermal desorption method..
- (2) For non-EPC systems, check split flow during Inject time (after 20 seconds) to verify appropriate flow through the Desorption Unit. If flow is too high or too low, adjust with the flow controller on top of the Desorption Unit. This adjustment should only have to be done once for a given set of instrument conditions. Extending the injection time for the first run may aid in making the adjustment.

## **Special Methods**

Gas chromatographs that are used often for liquid injections may harbor contamination in the injection port that may be seen in a thermal desorption blank but may not be evident with a liquid injection. This can be due to the turbulent flow of preheated helium entering the GC inlet during thermal desorption. The usual assumption is that the desorption unit has been contaminated; however, this is hardly ever the case, especially with a new unit. If the first blank (and sometimes subsequent ones) display a high baseline with many peaks, then it is probably time to run a bakeout method.

**Bakeout Method** – Recommended that the Bakeout Method be run before any samples are analyzed or when a sample is overloaded.

Create a bakeout method with parameters similar to these:

Oven temperature:	At or near the column maximum, isothermal
Oven Hold Time:	10 minutes
Inlet Temperature:	Column maximum up to 350°C
Inlet Mode:	Split ( $\geq 100:1$ )
Detector or Transfer line:	At or near the column maximum

## 7 - Standard Operating Parameters

### Thermal Desorber Settings:

Cryo-trap:	Disabled
Heater Blocks:	300 to 350 °C, isothermal
Purge Time:	1 minute, purge flow controller wide open
*Inject Time:	Less than <i>GC Gas Divert Time</i> specified in <b>System   Configure   Limits</b>
Desorb Time:	20 minutes
GC Start Time:	15 minutes

**Note:** By setting the **Inject** time shorter than the **GC Gas Divert Time**, the carrier diverter valves are not activated, allowing flow to enter the injector from both the desorption unit and the regular GC carrier inlet for the duration of the desorption process. The excess flow helps remove contaminants from the injector through the split vent. The default setting for **GC Gas Divert Time** is 20 seconds (0.33 minutes). A typical **Inject** time setting for a bakeout method is 0.2 minutes.

Save the data system method with a convenient name such as **BAKEOUT**. Run the method either by itself or as part of a sequence whenever inlet contamination is suspected, or as part of a regular inlet maintenance program. Remember to change the bakeout method parameters to include appropriate oven temperatures for your GC column.

Figure 7-1 illustrates the carrier flow path during the Purge and Inject times. In Figure 7-1A carrier gas (indicated by the dotted line) is delivered to the column from the Electronic Pressure Control (EPC) system of the GC, and purge gas is directed through the Desorption Unit by a separate route. Figure 7-1B illustrates the flow immediately after the needle has penetrated the septum (two separate flows are entering the inlet). This is the state that is maintained during the system bakeout. Figure 7-1C shows the flow path of the carrier after the diverter valves have been activated. Note that the EPC now supplies the inlet through the Desorption Unit. Locations where flow has been turned off are indicated by a symbol **X**.

7 - Standard Operating Parameters

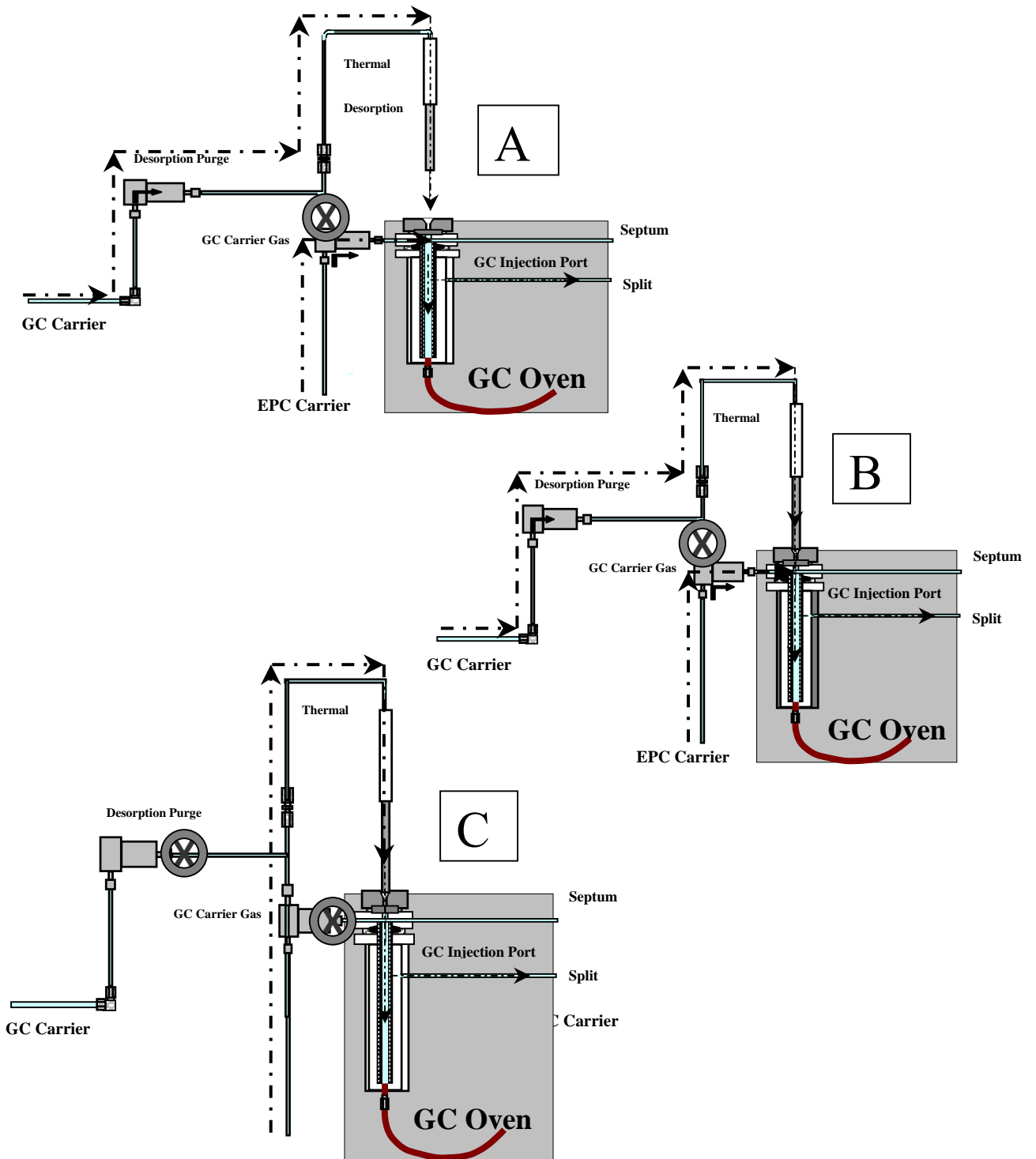

Figure 7-1 – Purge and divert gas operation



## 8. Troubleshooting

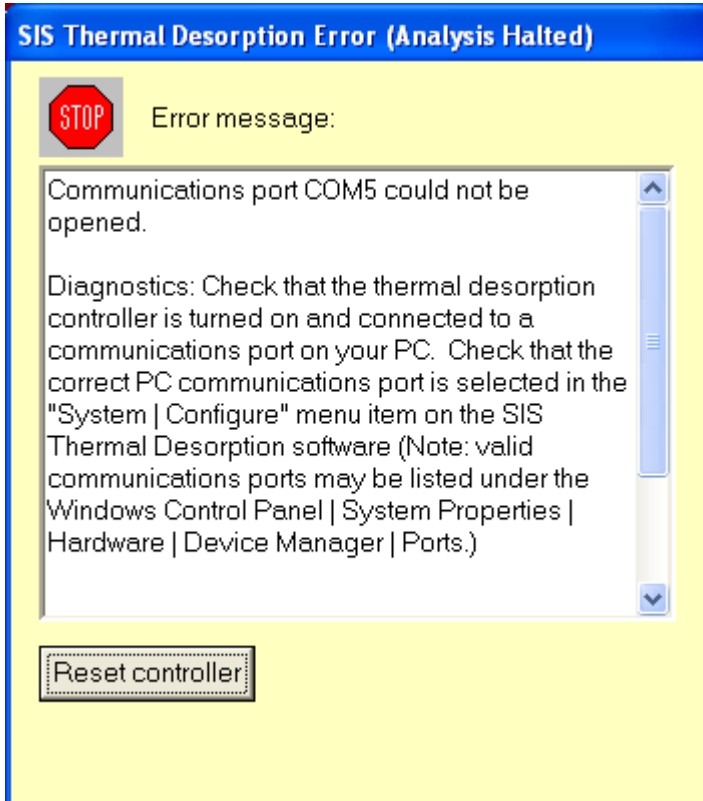

Figure 8-1 – Example error message in the Thermal Desorption Software

## Overview

This chapter is concerned with the diagnostic procedures to follow when problems occur with the TD-5. This section is divided into two areas in which problems can occur.

- A. Flow & Mechanical System
- B. Electronics Console

### A. Flow and Mechanical System Problems

#### (1) Problem - Pressure Gauge on Desorption System reads a higher pressure than normal when desorbing a sample into the GC injection port

##### Possible Causes

- (a) Clogged desorption tube needle
- (b) Ice plug in column

**Solution a** - A high pressure is usually an indication of a clog in the system, usually in the desorption tube needle. Compare the pressures displayed by the TD-5 and the pressure displayed by the GC injection port (if so equipped). Normally these two pressures should be the same within 1 or 2 psi. If the desorption pressure is much higher, then there is a clog in the system. Typically the clog will be found in the syringe needle. If the desorption pressure is much lower then there is a leak in the Desorption Unit. Uninject the desorption tube; the pressure reading of the desorption system gauge should drop quickly - if it does not then the needle is probably clogged. Unscrew the needle to confirm this source of clogging. With use the needle can become clogged with septa or graphite from the sealing ferrules or perhaps a previous sample that was analyzed. The needles can be cleaned by baking out if contaminated with volatile samples or with a cleaning wire if clogged with septum and graphite.

**Note:** We do not recommend standard 20° point needles for use with the desorption system. When these needles are used, they tend to core the GC septum and the plug removed from the septum stays inside the needle. Therefore we recommend side port needles with the system to eliminate this coring problem.

**Solution b** - If samples which contain high water content are thermally desorbed into the GC and cryo-focused at the front of the GC column, ice plugs can occur. This can be eliminated by one of the following:

1. Use smaller samples
2. Install a 0.5 to 1.0 meter megabore deactivated fused silica guard column in front of the regular GC column to minimize the chance of ice plugs. This also will improve resolution on early eluting peaks.

## 8 - Troubleshooting

3. Use a larger diameter capillary column or a packed GC column.
4. Trap volatiles purged from the samples onto a Tenax or other adsorbent resin which has a low affinity for water, and then subsequently desorb the traps into the GC.

### **(2) Problem - Zero reading or low pressure reading on the TD-5 Pressure Gauge when desorbing sample into the GC injection port.**

#### **Possible Causes**

- (a) Leaking Seal at needle connection to desorption tube
- (b) Leaking seal at top of desorption tube to connecting tube
- (c) Bad GC Septum
- (d) No carrier gas is being supplied to the desorption system
- (e) Broken GC Column at the injection port

#### **Solutions**

The most likely cause of low or zero pressure readings on the TD-5 is leaks in the desorption tube. The most likely location for such a leak is at the seal between the needle and desorption tube. Leaks can also occur between the desorption tube and the connecting tube. Either tighten these fittings or replace the seals. One can easily check the desorption system by uninjecting the desorption tube and needle and sliding an old GC septum over the needle. With the carrier gas flow On through the desorption system, the pressure should rise fairly quickly and settle out at the carrier gas pressure being used. If the pressure does not rise or rises too slowly there is a leak in the system. This leak should be able to be located with Snoop leak detection fluid with the needle plugged as described above.

If the problem is not located in the desorption system, then it is probably in the GC injection port. Check the GC injection port septum - if it is bad, replace it. Also check the GC column. The column may be broken or the column fitting at the injection port may be loose.

### **(3) Problem - Ball stuck in Rotameter**

**Cause** - Dirt or contamination has entered the rotameter glass tube

**Solution** - Remove the rotameter glass tube and clean. Call S.I.S. Tech Support for more information.

### **(4) Problem - Bending Needles**

**Cause**

## 8 - Troubleshooting

- (a) Misalignment of needles on injection
- (b) Incorrect injection port
- (c) Septum nut adapter not in place

### **Solution**

When setting up the system and installing the desorption tube and needle, visually inspect to be sure the needle is close to being centered over the hole in the desorption system middle plate. If misaligned, gently straighten to the approximate center position. Also check that the septum nut adapter is in place and sitting squarely over the septum nut.

If an on column injector is being used, the desorption needle may not fit inside the capillary column (even if a megabore guard column is used in the injection port). Either use a smaller O.D. needle which will fit inside the guard column or use a conventional split/splitless injector.

### **(5) Problem - Ice Plugs in GC column when cryo trapping components during the desorption process.**

**Cause** - water content of sample being analyzed is too high.

### **Solution**

1. Using smaller samples
2. Install a 0.5 to 1.0 meter megabore deactivated fused silica guard column in front of the regular GC column to minimize the chance of ice plugs. This also will improve resolution on early eluting peaks.
3. Use a larger diameter capillary column or a packed GC column.
4. Trap volatiles purged from the samples onto a Tenax or other adsorbent resin which has a low affinity for water, and then subsequently desorb the traps into the GC.

### **(6) Problem - No peaks are present on the GC or Mass Spec chromatogram.**

**Causes** - no sample is reaching the detector due to:

- (a) Leaks in the desorption system
- (b) Bad GC Septum
- (c) Broken GC column
- (d) Split ratio too high
- (e) Sample size too small
- (f) Ice plug in column
- (g) Clogged desorption tube needle

### **Solution**

## 8 - Troubleshooting

(a) Leaks in the flow path of the desorption system are the most common cause for the absence of GC peaks in the chromatogram. These leaks usually occur at the desorption tube needle during injection and desorption. Check the pressure gauges and flow rotameters on the desorption system during the desorption process. The rotameter should read some positive flow and the pressure gauge should be close to the injection port pressure reading. Both of these readings can be used to check for desorption system leaks, clogged needles, broken GC columns or ice plugs as described previously in this section.

(d) Depending on the sample size being used, the split ratio may be too high. Vary the sample size being analyzed and adjust the split ratio or run splitless as required. Measure the split flow at the split vent using a flow meter.

### **(7) Problem - Desorption system heater blocks will not close around the sample in the Auto Mode of operation. System reads “PRESSURE LEAK”**

#### **Cause**

(a) Desorption system head pressure is less than 3 pounds of pressure due to:

- (1) purge gas flow too low
- (2) bad septum
- (3) broken or disconnected GC column
- (4) insufficient time for injection time cycle
- (5) leak in desorption system

(b) Defective pressure switch in the desorption system

#### **Solution**

In the automatic mode of operation, a pressure switch is activated which will not permit the desorption system heater blocks to close unless the head pressure in the desorption system is more than 3 pounds. If there are leaks in the system or the GC septa is bad, the desorption system pressure will be less than three pounds of pressure, the message “PRESSURE LEAK” will be displayed on the Electronics Console and the blocks will not close. Find the source of leaks as outlined above to correct the problem. If using megabore columns which require head pressures less than three pounds of pressure, the pressure switch can be adjusted for a lower pressure. See Section 4 for details on the adjustment of this switch. If preferred the system can be operated in the manual mode. When operated in the manual mode, the pressure switch is not active, and the desorption system blocks will close regardless of the system head pressure.

It is also possible that the pressure switch is defective. If the pressure switch cannot be adjusted as outlined in the manual, then it should be replaced. Call S.I.S. Tech Support for more information.

**(8) Problem - Desorption system heater blocks will not heat**

**Causes**

- (a) Heater fuse on the electronics console is blown
- (b) Overheat sensor switch on the Desorption Unit has been activated.
- (c) Heater cartridge on the heater block is blown
- (d) Platinum Resistance Thermometer is defective
- (e) Cable between Electronics Console and Desorption Unit is disconnected or defective

**Solutions** - Check the main power fuses on the desorption system Electronics Console and make sure the connecting cable is installed. If the problem is still apparent, remove the side from the Desorption Unit and reset the over heat sensor circuit breaker on the back plate (red button). If this does not solve the problem, the heater cartridge or PRT is bad and will need to be checked out by a qualified technician at SIS.

**(9) Problem - GC peaks are broad at beginning of chromatogram**

**Causes** - Cryo Trap temperature not low enough

**Solutions** - We have found that we can trap and resolve compounds with melting points 0 to 10° below the cryo trap temperature. Therefore if the cryo trap is set at -40° C, then we can routinely trap compounds with melting points down to -50° on an uncoated deactivated fused silica capillary column. In general we have found the best results using a megabore deactivated fused silica precolumn or guard column with all capillary columns. This megabore column provides a greater I.D. and surface area to minimize water plugs. In addition the use of uncoated guard columns as a cryo-trapping area provides for better peak shape and resolution versus trapping directly on the liquid phase of the capillary column. If the trapping area of the guard column is coated with a liquid phase the trapping efficiency can be improved provided that the liquid phase is still active at the set temperature (e.g. DB-WAX can not be used at cryo temperatures). Using a thick film megabore guard column (5.0 µm film thickness x 0.53 mm I.D. DB-5) we can quantitatively trap compounds with melting points 40° below the trapping temperature.

**(10) Problem - Extraneous Peaks in Chromatogram**

**Cause** - Extraneous peaks can occur in the GC chromatogram or the Mass Spec total ion chromatogram. The cause of these peaks can be one or more of the following:

- (1) Contaminated desorption tube
- (2) Contaminated desorption tube needle
- (3) Contaminated connecting tube
- (4) Contaminated GC Septum
- (5) Contaminated injection port liner or injection port
- (6) Bleeding GC Septum

## 8 - Troubleshooting

- (7) Injection port too hot
- (8) Bad GC guard column
- (9) Guard column or capillary column was over heated, decomposing liquid phase on column
- (10) Desorption temperature too hot
- (11) Contaminated GC carrier gas
- (12) Breakdown of Adsorbent resins in packed thermal desorption tubes
- (13) Contaminated Carrier Gas line traps
- (14) Injection port and carrier gas lines are contaminated

### Solutions

Often three peaks are present in the chromatogram resulting from either septa bleed or GC column coatings. If the analysis is being done on a mass spectrometer, these three peaks will have most abundant ions at 207, 281 and 355 (or 267) consecutively. These correspond to the siloxanes used to either coat the capillary columns or bleed from the silicone septa. These three siloxane compounds are:

- a. Hexamethylcyclotrisiloxane (M.W. 222) - major mass spec peaks at 207
- b. Octamethylcyclotetrasiloxane (M.W. 296) - major mass spec peaks at 281
- c. Decamethylcyclopentasiloxane (M.W. 370) - major mass spec peaks at 355 and 267

In a normal GC run these compounds are the reason for background in the chromatogram. However in the thermal desorption process, samples are injected over 5 to 10 minutes and trapped at the front of the GC column. If these siloxanes originate at the septum or from the guard column itself at the injection port end of the column, they will be trapped in the cryo trap section of the GC system and result in distinctive peaks in the total ion chromatogram. They can be minimized by using low bleed septa (we recommend Supelco's Thermogreen Septa), replacing the septum regularly, keeping the injection port at the minimum temperatures required for the analysis, regular replacement of the guard column and minimizing the upper temperatures to which the guard column and capillary column are subjected. These steps will minimize the decomposition of the septum and column coatings. Also note that the higher the desorption block temperature as well as the injection port temperature, the more pronounced these siloxane peaks appear in the total ion chromatogram. Best results are always obtained at the lowest possible desorption block and injection port temperatures required to perform the analysis on the compounds of interest.

If the contaminant or background peaks are not siloxanes, then the source of contamination should be located by checking or changing each of the problem areas outlined above. Begin by installing a baked out and clean desorption tube and needle on the desorption system. Repeat the analysis.

If the peaks still appear, remove the connecting tube from the desorption system and bake out in the conditioning oven at 300 to 350 degrees C for 1 hour. If powdered samples

## 8 - Troubleshooting

were analyzed without glass wool plugs being placed on top of the samples before thermal desorption, it is possible for these samples to blow back and up into the connecting tube when the carrier gas flow through the desorption system is turned off. It is recommended that glass wool plugs be inserted on top of all solid powder samples in the desorption tubes to eliminate this blow back from occurring. After the connecting tube has been baked out, reattach it to the desorption system along with a clean and baked out desorption tube and needle. Repeat the analysis.

To verify that no contamination is originating from the desorption system, attach the carrier gas line directly to the connecting tube using a clean stainless steel gas line and a needle valve in line to control the carrier gas flow. This will by-pass the entire desorption with the exception of the connecting tube, desorption tube and needle. Repeat the analysis. If the contaminant peaks disappear, then the problem is contamination in the desorption system. Replace the Teflon coiled connecting tube. Recheck the system. This should correct the problem.

If the extraneous peaks still occur, then the problem is in the GC injection port end of the GC system. Begin by replacing the GC septum, installing a new injection port liner or cleaning the GC injection port and replacing the GC guard column or removing several inches from the front of the GC column. Bake out the injection port before the column is reattached. Repeat the analysis.

If the problem still persists, the only sources left for checking are the GC column itself and the GC carrier gas purity. Replace the GC column. Install a new carrier gas tank and replace the hydrocarbon and oxygen traps of the carrier gas lines. It is also possible that the entire GC injection port may have been contaminated by a previous analysis in which large volumes of solvents were syringe injected in to the GC injection port which backed up into the GC injection port lines, contaminating the entire GC plumbing system lines. If this is the case the GC injection port and accompanying plumbing will need to be broken down, plumbing lines and traps cleaned or replaced, baked out and reassembled. See S.I.S. website at [www.sisweb.com](http://www.sisweb.com) for more information.

Users doing Direct Thermal Extraction work or analyzing compounds not well bound to adsorbent media may experience some carryover. This results from the depressurization of the injection port, which causes a momentary net backward flow of carrier after injection. The most common cause of this problem is the use of powdery or friable samples which may be carried back into the desorption unit with the backward gas flow. The use of inappropriate trapping media may also contribute to this type of contamination, as inadequately bound volatiles may also be swept back into the system.

Naturally, the choice of an appropriate adsorbent can rectify the problem in the latter case, and the addition of a small conditioned glass wool plug inserted on top of the sample may help in the case of DTE samples. However if the desorption unit has been substantially contaminated, or if the unit is to be used frequently for samples which pose this type of problem, the connecting tube may be packed with an adsorbent material to provide a final carrier filter that can be regenerated if contamination occurs:



## 8 - Troubleshooting

- a. Remove the connecting tube by disconnecting the Teflon™ carrier line at the top, then removing the three round-head cap screws from the tube mounting bracket with a 1/8" Allen wrench.
- b. Remove the Vespel Seal with Cartridge (SIS # 786017) from the Connecting Tube by threading the Seal Removal tool ( SIS #786910) all the way into the threaded hole of Vespel Seal. You will need to use a little force to remove it. The Vespel Seal with Cartridge can be heat conditioned. Do not heat over 350C.
- c. Insert a plug of clean silanized glass wool into the bottom of the tube and use a long, thin instrument such as a length of 1/16" tubing to seat the plug in the top of the connecting tube.
- d. Pack the tube with 1-3 grams of adsorbent. Spherical molecular sieve materials such as Carboxen™ or Carbosieve™ are recommended, as they provide less backpressure. Graphitized activated Charcoal (GAC) materials may also be used, provided the mesh size is not too small.
- e. Insert a plug of silanized glass wool into the tube and seat it with a suitable tool to hold the adsorbent material in place. Replace the graphite and graphitized Vespel™ seals.
- f. Remove the Teflon™ tubing from one of the handles on the desorption tube conditioning System and attach it to the packed connecting tube. Place the connecting tube into the conditioning oven and condition for at least two hours at 300 °C with 30-40 ml/minute gas flow.
- g. Carefully remove the tube from the oven and allow it to cool with gas flowing through it. Reattach the tube to the Teflon™ carrier line on the desorption unit, and replace the three screws. Before tightening the screws, make sure there is approximately 3/16" between the bottom of the hex nut on the connecting tube and the top of the tube mounting bracket.

(11) Problem - Injection or Uninjection too slow or too fast

**Cause** - Air pressure too high or too low

**Solution** - When the desorption systems are set up in the factory, they are adjusted to operate optimally at 60 psi of compressed air for all the air solenoids and columns in the system. Check the air pressure to the Desorption Unit to be sure that it is delivered at 60 psi. At this point, the system can be adjusted to operate slightly faster or slower by changing the air pressure. An increase in air pressure (use care not to exceed 100 psi) will cause the injection process to speed up. Likewise a lower pressure (do not use less than 10 psi) will cause the system to operate more slowly.

### ***B. Electrical System***

(1) Problem - No Power to the System, power switch does not light up.

**Causes**

## 8 - Troubleshooting

- (a) System not plugged in or power line is dead.
- (b) Fuses Blown on back of Electronics Console
- (c) Electronics Console is in need of service

**Solution** - Check that the power cord is plugged into the electrical socket. Check and or replace the fuses. If fuses are blown and continue to blow, unit should be serviced by a qualified technician at SIS.

### **(2) Problem - Heater temperature does not change or is far from set point.**

**Possible cause** - Heater cartridge burned out or defective.

**Solution** - Remove interface cable from unit. Using an OHM meter take a resistance reading between pins 1 & 2. The reading should be approximately 22 OHMS. If the reading is approximately 44 OHMS then one of the heater cartridges is burned out or defective. Unit should be returned to SIS for repair.

### **(3) Problem – Error message “Could not communicate with controller” possibly also with “Returned error: Returned string bad.”**

**Cause** – The Thermal Desorption Software cannot communicate with the Electronics Console. Reasons include

- (a) Electronics Console is not turned on.
- (b) Electronics Console is not connected to the PC via the RS-232 communications cable.
- (c) The correct serial port is not selected in the Configure System dialog box.

**Solution** – Ensure Electronics Console is turned on and properly connected to the PC. Check the serial port setting in the **Configure System** dialog box by selecting the **“System | Configure...”** menu item.

## 8 - Troubleshooting

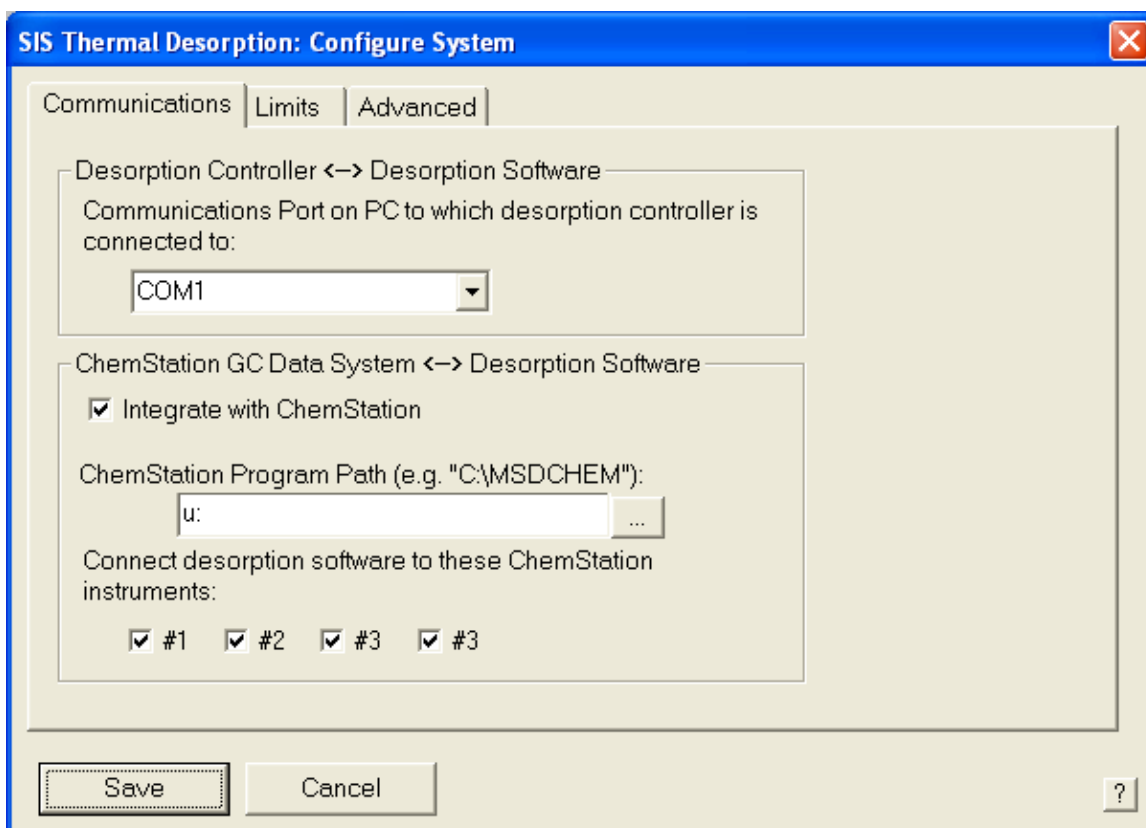

**Figure 8-2 – Configure System dialog box with Communications Port setting.**

## 8 - Troubleshooting

# 9. Desorption Tube Conditioning System

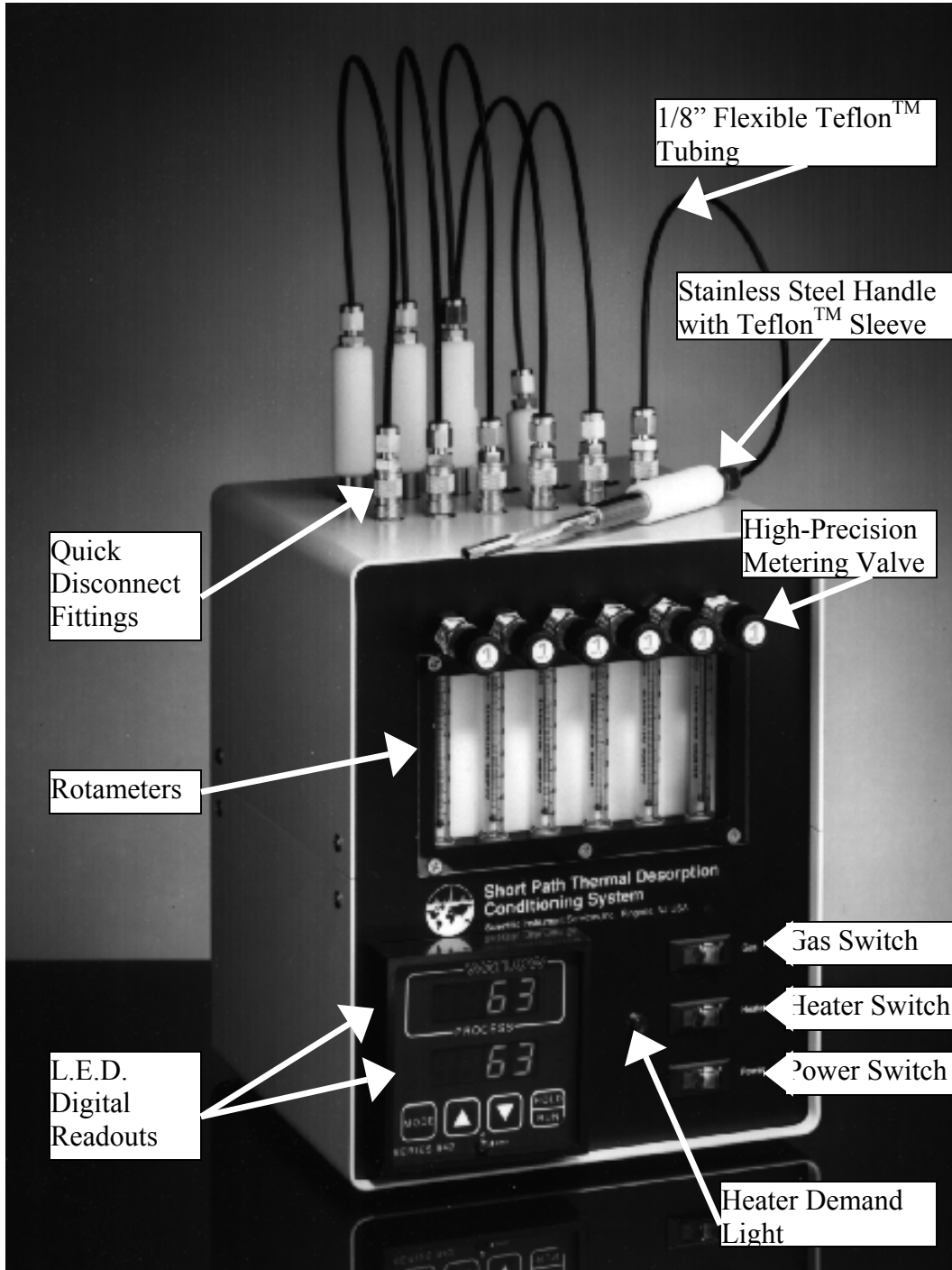

Figure 9-1 – Desorption Tube Conditioning Oven – Front View

## ***I. Introduction***

### **A. Theory of Operation**

The Desorption Tube Conditioning Oven is recommended for the flow conditioning of packed glass-lined stainless steel (GLT) or silco-coated desorption tubes as well as for the flow conditioning of desorption tube needles (Figure 9-2). A high purity gas such as helium or nitrogen is recommended for use in this system to purge the packed desorption tubes while baking out at elevated temperatures. By proper conditioning of the desorption tubes and adsorbents, one can be assured that no foreign contaminants will interfere with or contribute to the composition of the samples being analyzed. The system consists of six flow adjustable rotameters and a heater block with six ports (0.40" I.D. x 4.0" deep) for the cleaning of six desorption tubes or needle caps simultaneously at temperatures up to 350°C. A Watlow precision programmable temperature controller provides the heater circuit to heat the blocks and permits the programming of the temperature at which the tubes are to be conditioned. Temperature programs of up to six steps with various ramp cycles and hold times can be programmed into the controller for the unattended conditioning of the desorption tubes. Programs are stored in the system's memory. Accuracy of the programming temperatures is +/- .1% of the full scale reading. An L.E.D. digital readout displays the set temperature and the actual temperature of the system, and the bubble meters indicate the flow through each desorption tube or needle.

## ***B. Safety - Warning Messages***

WARNING Do not condition tubes or needles above 350 °C otherwise damage may occur to heater blocks or internal circuitry.

WARNING Maximum gas pressure is 60 P.S.I.

WARNING Do NOT use Hydrogen Gas in the Conditioning Oven. Use only Helium or Nitrogen.

WARNING Make sure that only fuses with the required current rating and of the specified type are used for replacement. The use of incorrect or makeshift fuses or the short-circuiting of fuse holders creates a shock hazard for the operator and can damage the instrument.

WARNING Do NOT increase temperature range of heat overload current.

WARNING If the System overheats, return to manufacturer for all service. Any adjustments, maintenance or repair of the opened instrument while it is connected to a power source must be avoided.

WARNING Do NOT leave Conditioning Oven heaters in the heated ON position unattended overnight. The Conditioning Oven heaters rapidly heat and cool to their final operating temperatures and therefore, in order to prolong their life and avoid premature failure of the system they should be turned off when not actively being utilized to condition tubes or needles.

WARNING Use grounded outlet only. Connecting the Conditioning Oven to a power source which is not equipped with a protective earth ground contact creates a shock hazard for the operator and can damage the instrument.

WARNING Hot surface exposed. Do NOT TOUCH Desorption Tubes or needles when removed from heater block. Use Teflon Handles to remove tubes & needles from block. Allow to cool before touching.

WARNING Do Not condition needles on the desorption tubes. Condition desorption tubes and needles separately using appropriate handles.

## 9 - Desorption Tube Conditioning System

### **B. Specifications**

#### 1. **Electrical Specification**

##### **Power Requirements**

Voltage - 110 VAC

Current - 10 amps maximum

Electrical Cord - 110 v/grounded outlet

##### **Temperature Controller**

Heater Circuit - Accuracy - +/- .1% of full scale - Range - up to 350°C

Heater output - 115 volt, 600 watt

Sensor Input - Platinum Resistance Thermometer

Heater Cartridges - 4 each - 115 v, 150 watts

Digital Readout for set & actual temperatures 3 or 4 digit

Temperature Range - Room Temperature to 350°C

Programmable – autocalibration temperature controller

#### 2. **Gas / Pressure Specification**

Type - Nitrogen or Helium (high purity)

Maximum pressure - 60 P.S.I.

Flow - Maximum 50 ml / min per tube

- Maximum total 300 ml / min

Quick disconnects - automatically turn off gas

#### 3. **Weight and Dimensions**

Weight - 12 pounds

Size - 9" wide x 9" deep x 13" high



### **C. Warranty & Service**

**Warranty** -The Desorption Tube Conditioning System is warranted against defects in material or workmanship for a period of 90 days commencing from the date of shipment from the warehouse of Scientific Instrument Services in Ringoes, NJ, hereafter referred to as the company. The company's liability on the Desorption Tube Conditioning System and accessories is limited to the cost of correcting the defect in the product. In no case shall the company be liable for consequential or special damages. The system should not be run unattended overnight. The company will not correct defects caused by buyers negligence. The company does not guarantee or warrantee the product for any particular purpose. The companies warranty shall end 90 days after shipment.

**Extended Warranty** - An extended one year warranty for parts and labor is available if purchased within 30 days of shipment of the unit. The one year extended warranty will cover parts and labor to repair the Desorption Tube Conditioning System within the facilities of Scientific Instrument Services. Service on customers' facilities is not available.

**Service and Repair** - The Condition System should be serviced only by qualified SIS staff. Any equipment to be serviced under warranty or otherwise should be sent to the repair facilities of Scientific Instrument Services in Ringoes, NJ. No on- site service is available. A Return Authorization Number (RA#) must be obtained from the offices of Scientific Instrument Services before any equipment is returned.

Scientific Instrument Services, Inc.  
1027 Old York Road  
Ringoes, NJ 08551  
Attn: Repair Department  
RA# \_\_\_\_\_  
Phone: (908) 788-5550

## 9 - Desorption Tube Conditioning System

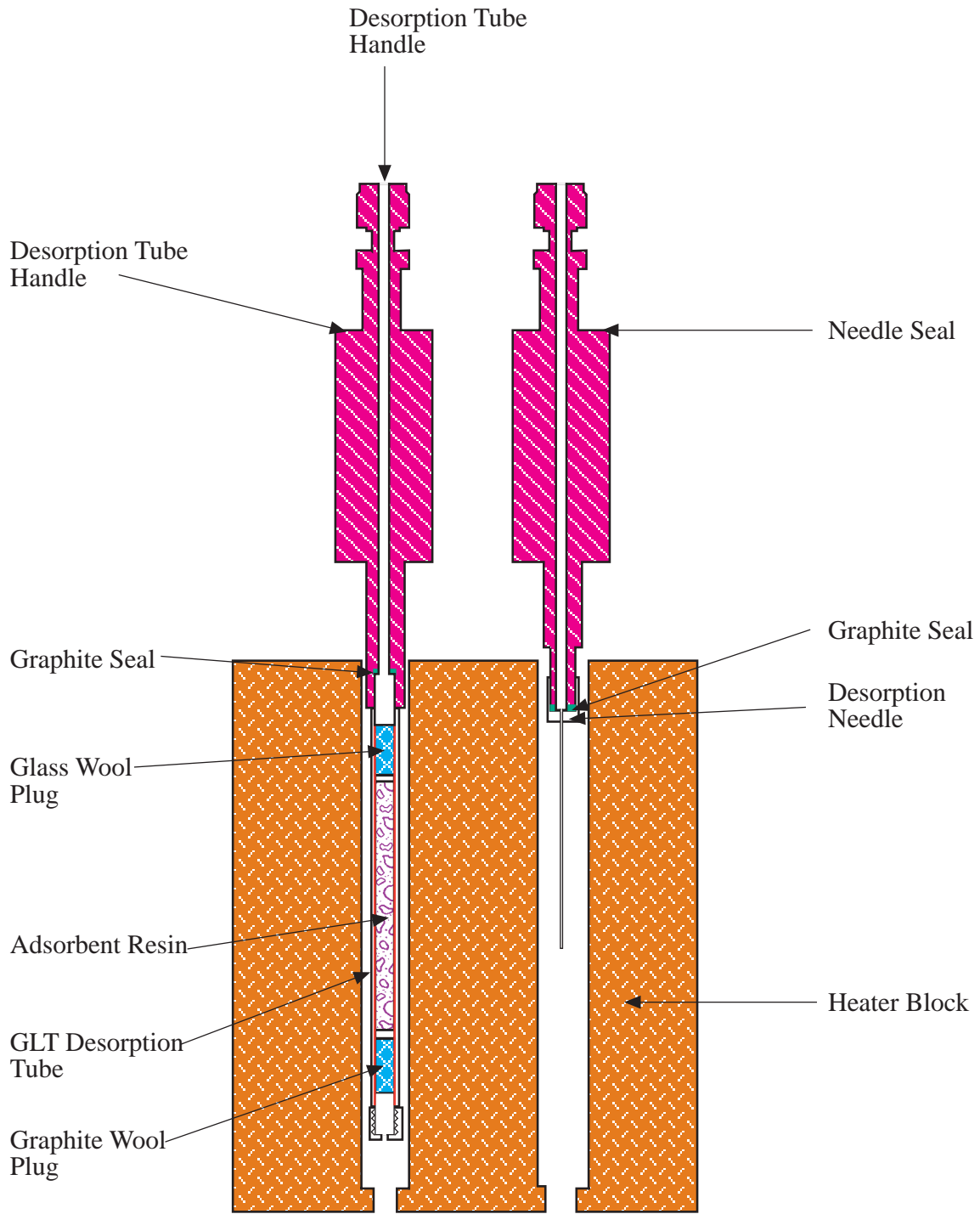

**Figure 9-2 – Desorption Tube Conditioning Oven Theory of Operation.**

9 - Desorption Tube Conditioning System

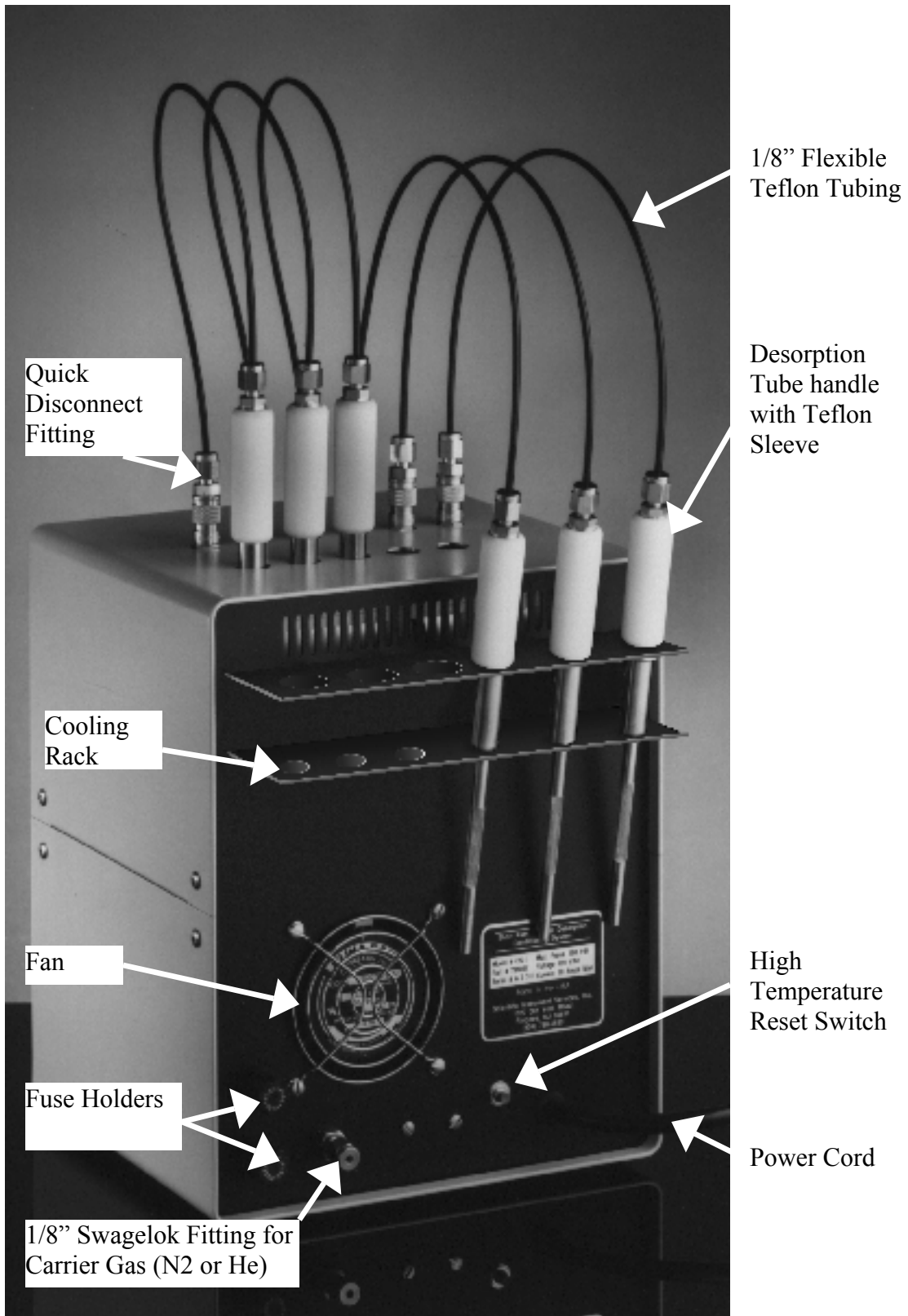

Figure 9-3 – Desorption Tube Conditioning Oven – Rear View

## II. System Description

### A. Front Panel Description (Figure 9-1)

Three on/off switches are present on the front panel including a main power switch, a heater switch and a gas switch. The main power switch controls the power to the entire Conditioning Oven, to the temperature controller, and other switches. The heater switch turns on the power to the heater cartridges in the heater block and begins its heating cycle. The carrier gas switch turns on the carrier gas to permit its flow through the desorption tube. An L.E.D. digital readout displays the set temperature and the actual temperature of the system. A heater demand light indicates the actual heating demand of the heater blocks. If the demand light is bright red the heater is on; heater is off when there is no light. If the demand light is dim red, the heater is unplugged or an open circuit exists. Each of the flow rates for the desorption tubes and needles can be monitored by the six rotameters and flows adjusted with the high precision metering valves.

The self contained system includes six adjustable bubble rotameters with flow ranges of 0 to 50 ml/min, one for each of the tubes or needles to be conditioned. The recommended flow rate is 20 ml/min. Flow meter calibration data for air and helium are listed in Table I. Each of the flows through the tubes can be independently controlled or flow turned off to that port via a high precision metering valve. A single electrically operated solenoid valve turns the gas flow off or on to all the ports via the Gas Switch on the front panel. The quick disconnect fittings on the top of the Conditioning Oven turn the flow off to individual gas flow lines when disconnected (Figure 9-5).

Two types of Conditioning Oven Handles are available, one for attaching the desorption tubes and the other for attaching stainless steel needles (Figure 9-4). All systems are shipped with six desorption tube handles and two needle handles. The handles are constructed from stainless steel with Teflon sleeves. The gas connection fitting is a standard 1/8" Swagelok fitting. Graphite seals with metal inserts (part #781015) are recommended for sealing the desorption tubes to the handles during conditioning. Graphite seals are physically soft but have excellent sealing properties and temperature limits and are recommended for most applications with the Conditioning system. When soft materials such as graphite are used, a metal tube is inserted inside the center hole in the seal to prevent the graphite from closing and restricting gas flow. Other sealing washers could also be used if preferred for lower temperature cleaning.

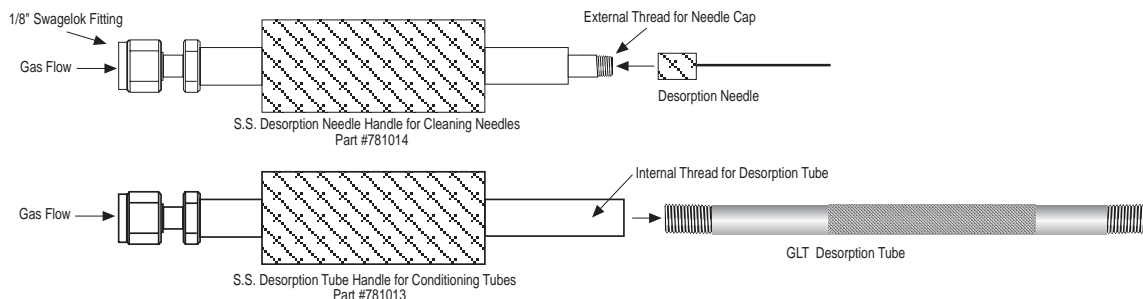

Figure 9-4 – Conditioning Oven Handles

### **B. Rear Panel Description (Figure 9-3)**

Electrical power is provided from a standard 110 volt, 10 amp grounded outlet. A single 1/8" Swagelok fitting on the back of the Conditioning System provides for the attachment of the carrier gas from its source. An external high temperature reset switch is located in the rear of the oven so that if temperatures exceed 350°C on the heater block, the external reset will open and heat to the block will stop. This switch can be reset by simply pushing this red button once the block has cooled. Two Slo Blo fuses are mounted in the rear of the Conditioning System to handle the initial surges of the Main Power and Heater switches when they are turned on.

In addition, a three inch fan enclosed on the back side of the Conditioning System provides a steady flow of air through the system to maintain the temperature of the temperature controller, rotameters, and other components inside the system at an acceptable level and to provide for cooling of the heater block once the heater circuitry is turned off.

After conditioning the desorption tubes and needles are removed and placed in a cooling rack attached to the back of the Conditioning System and cooled under constant flow. As soon as the tubes are touchable (5-10 min), they are immediately capped on both ends with stainless steel caps with Teflon seals that have also been conditioned.

**III. Gas Flow Circuit**

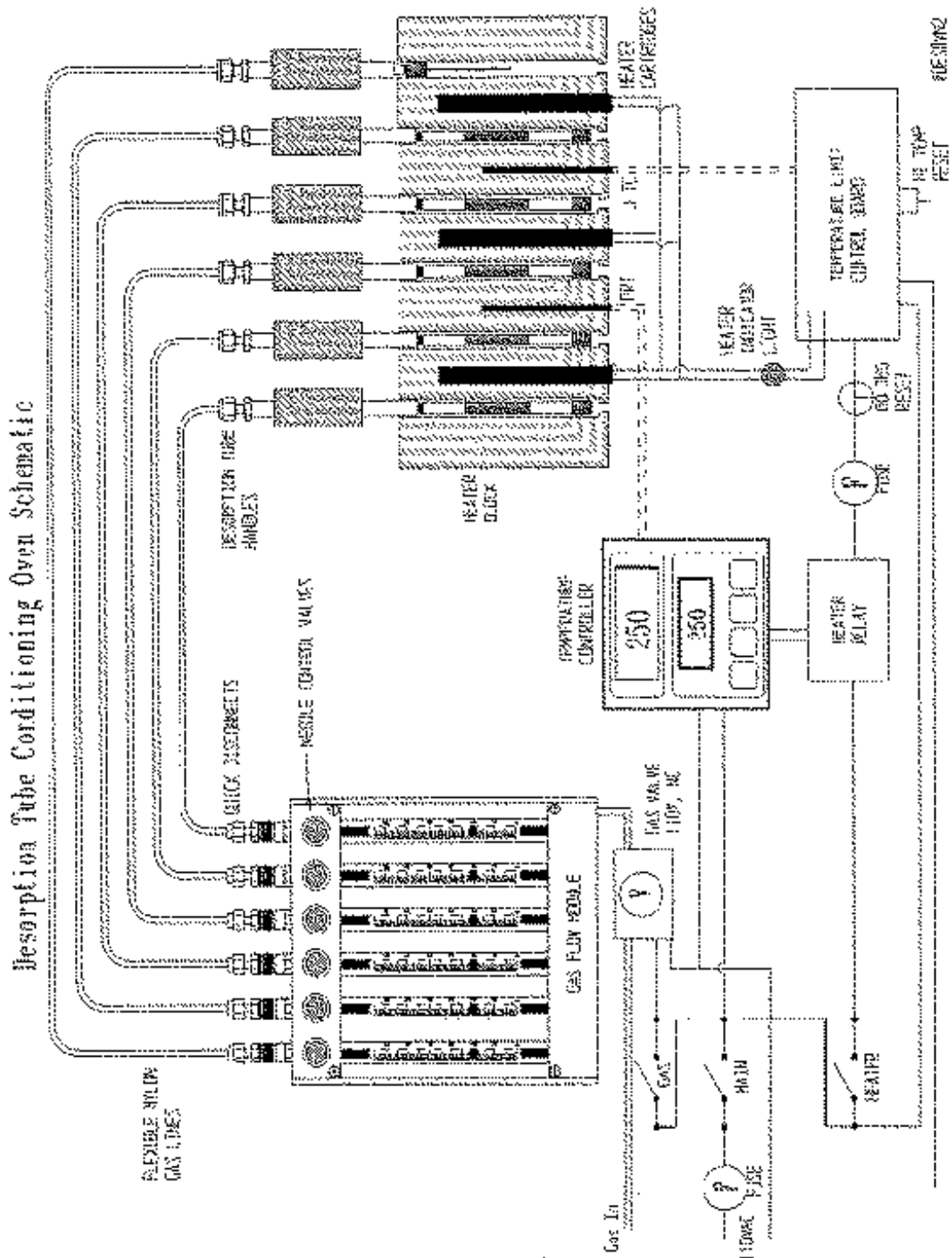

Figure 9-5 – Desorption Tube Conditioning Oven Schematic

## 9 - Desorption Tube Conditioning System

The Desorption Tube Conditioning Oven schematic (Figure 9-5) pictorially represents the overall operation of the system including the gas flow and heater circuits. A 110 volt outlet is required, and 10 amps provides the total electric power required for system operation.

The self contained system includes six adjustable bubble rotameters with flow ranges of 0 to 50 ml/min, one for each of the tubes or needle to be conditioned. Each of the flows through the tubes can be independently controlled via a microneedle valve and the flow turned off to that port if no flow is required. A single electrically operated solenoid valve (v) turns the gas flow off or on to all the ports via the Gas Switch on the front panel (Figure 9-5).

On top of the Conditioning Oven six quick disconnects connect to 1/8" flexible Teflon tubing to provide gas flow through the desorption tubes and needles during conditioning. When a quick disconnect is removed the gas flow is automatically closed to that port. By providing gas flow from a carrier gas such as high purity nitrogen or helium through the desorption tubes and needles while conditioning, it can be assured that no oxygen enters the desorption tubes which could destroy the adsorbent material. Impurities from the inside of the desorption tubes and needles are flushed from the interior surface of these parts. A single 1/8" fitting on the back of the Conditioning System is provided for the attachment of the carrier gas from the source (Figure 9-5 - (Gas in)).

### **IV. Heater Circuit**

The Conditioning Oven includes a heater block with six ports (I.D. 0.40" x 4.0" deep) for the cleaning of six desorption tubes or needles simultaneously at temperatures up to 350° C. A Watlow precision programmable temperature controller permits the programming of the temperature at which the tubes are to be conditioned. The heater block contains a platinum resistance thermometer (PRT) for accurate (+/- .1%) temperature readout and provides the feedback to the temperature controller to maintain the heater block temperature. A J type thermocouple (TC) is also present in the heater block and serves as the temperature sensor for the high temperature limit control circuit. Four 3/8" diameter, 150 Watt heater cartridges heat the aluminum heater block. The heater cartridges are wired in parallel and are fused by their own 10 amp slow-blow fuse. A separate heater switch on the front panel permits the manual turning OFF and ON of the power to the heater cartridges. A 60° C heat overload sensor is attached to the inside of the Conditioning Oven case to protect against the excessive heating of the circuitry inside the Oven case. Two overheat protection circuits are built into the Conditioning Oven as described below. The heater indicator light (on the front panel) displays the power demand for the heater cartridges. When brightly lit, power is being supplied to the heater cartridges; when off, no power is supplied to the heaters. When dimly lit, the circuitry to the heater cartridges is open within the Conditioning Oven.

#### **A. Heater Protection Circuitry**

A heat overload thermostat (internal 60° C reset switch) is located inside the Conditioning Oven case to prevent the interior case and electrical components from being

## 9 - Desorption Tube Conditioning System

subjected to excessive heat. If the oven case should exceed 60° C due to a circuit failure (such as failure of the cooling fan to operate), this overload sensor will open the circuit that provides power to the heater cartridges. This overload sensor can only be reset by allowing the system to cool, opening the Conditioning Oven case, and manually resetting the internal overload reset switch. If the heat overload thermostat should open when operating the system, the entire Condition Oven should be returned to the factory for service. Service should only be performed by qualified electrical technicians knowledgeable of the system electrical circuits.

A high temperature limit control board with an external high temperature reset switch (Figure 9-3 and Figure 9-5 - Hi temp reset) prevents the heater block temperature from exceeding 350° C. If the block temperature exceeds 350° C, the external reset switch will automatically open the power circuitry to the heater cartridges. Power cannot be restored to the heater cartridges until the heater blocks are allowed to cool and the external reset switch is manually reset (Figure 9-5). Note: Do not exceed 350° C for the Conditioning Oven heater blocks. Higher temperatures will damage internal circuitry and create a potential meltdown and electrical hazard.

### B. Watlow Temperature Controller

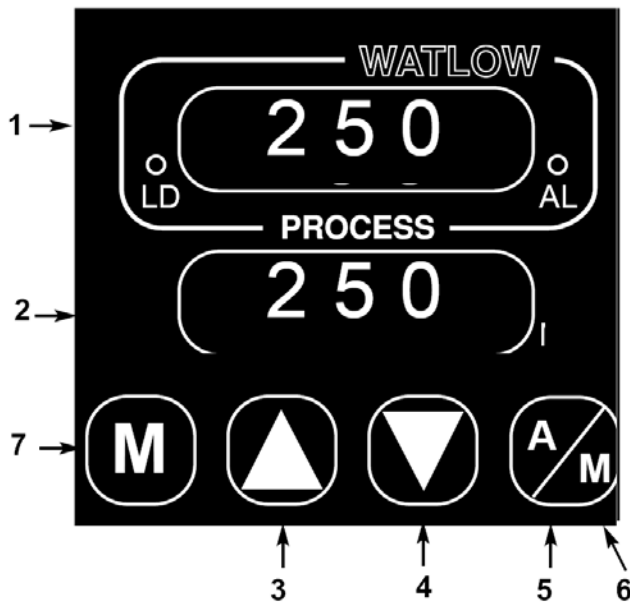

Figure 9-6 – Watlow temperature controller keypad/display

The Watlow microprocessor based temperature controller (Figure 9-6) provides the heater output to the Conditioning Oven heater blocks. The system can either be run isothermally (Manual Operation) at a set and constant temperature or alternatively can be temperature programmed or temperature ramped (Automatic Operation) via a user selected temperature program. Procedures of up to six steps with various ramp cycles and hold times can be stored in the temperature controllers memory for the automatic ramping of temperatures as the desorption tubes are conditioned. Accuracy of the



## 9 - Desorption Tube Conditioning System

programming temperatures is +/- .1% of the full scale reading. Two 0.56" red LED's display the set and actual temperatures for the heater block.

### Description of the Keys and Display

**1. Upper Display (Actual heater block temperature)** The red 0.56" (14 mm) high, seven segment, four digit LED display indicates the actual heater block temperature, in addition to parameter values, or an open sensor. When powering up, the displays will be blank for 8 seconds.

**2. Lower Display (SET temperature)** The red 0.56 (14 mm) high, seven segment, four digit LED display, indicates the temperature SET point for the system. This value can either be set manually via the up/down arrows or is defined and displayed in the automatic mode by the user selected temperature program.

**UP/DOWN keys** - The UP/DOWN arrow keys are used to manually set the desired value for the SET temperature as displayed in the lower LED display. When pressed down simultaneously for 3 seconds, the SETUP Menu appears.

**3. UP Key** - Increases the value of the SET temperature LED display. A single light touch increases the value by one. Hold the key down to increase the value at a rapid rate.

**4. DOWN Key** - Decreases the value of the SET temperature LED display. A single light touch decreases the value by one. Hold the key down to decrease the value at a rapid rate.

**5. HOLD/RUN Key** - Used to run or hold a temperature program. Press once to load the temperature program. Press a second time to start the temperature program. Pressing a third time will stop the temperature program and restore the controller to the manual (isothermal mode of operation).

**6. HOLD/RUN LED** - Lit when the control is running. When blinking, press the HOLD/RUN key again to begin running the temperature program.

**7. MODE Key** - Steps through the various menus such as the temperature program menu. Also automatically enters data before proceeding to the next parameter.

For additional features, control and system setup refer to the Watlow Controller Manual.

### Temperature Controller System SETUP

The purpose of the SETUP menu is to define the various operating parameters and condition of the temperature controller. These user selectable parameters include the conditions of controller operation, the calibration parameters, rate of heating, sensor input type, temperature scale (°C or °F), display decimal point location, and temperature range. The Watlow temperature controller has already been preset to the correct operating parameters at the factory and the user should not normally have needed to alter these factory settings. The SETUP Menu is entered by pressing both the UP and DOWN arrow keys simultaneously for 3 seconds. The values presently in the controller on the

## 9 - Desorption Tube Conditioning System

Conditioning Oven have been factory selected for the correct operation of the Conditioning Oven. It is NOT recommended that they be changed. For a detailed description of these parameters and the selections available refer to the Watlow Users Manual.

The factory preset values are listed below.

Setup Menu	Operation Menu		
LOC	O	Prog	no
In	rtd	Pb1	6
C_F	C	rE1	0.36
rL	0	rA1	0.27
rH	400	Ct1	5
Ot1	ht	CAL	0
HYS1	2	AUt	0
	rtd	din	
PtYP	rAte		
gSd	0		
POUt	Cont		

### **Isothermal or Manual Mode Operation of the Watlow Controller**

To operate the Watlow controller in the isothermal or manual mode of operation the following steps are used.

1. Turn on the Main Power Switch on the Conditioning Oven.
2. Turn on the Gas Switch.
3. Use the UP/DOWN arrow keys to select the desired temperature of the heater blocks (SET temperature is displayed on the lower LED display of the Watlow controller).
4. Turn on the heater switch. Within 5 minutes the heater blocks temperature (Upper display) should reach the same value as the SET temperature (Lower display).
5. Attach the desorption tubes and needles to the appropriate handles.
6. Insert the tubes and needles into the heater block ports.

### **Programmed Temperature Ramp or Automatic Mode of Operation**

In order to operate the Watlow temperature controller in an automatic or preprogrammed temperature ramp the following steps should be followed. Before running the system with a temperature program, the user must have previously entered the ramp temperature

## 9 - Desorption Tube Conditioning System

program stored in the systems memory as described in a subsequent section of this manual.

1. Turn on the Main Power Switch on the Conditioning Oven.
2. If the temperature program has not been installed, refer to the next section on how to install the temperature ramp program before proceeding.
3. Turn on the heater switch. Within 5 minutes the heater blocks temperature (Upper display) should reach the same value as the SET temperature (Lower display).
4. Attach the desorption tubes and needles to the appropriate handles.
5. Insert the tubes and needles into the heater block ports.
6. Turn on the Gas Switch.
7. Press the HOLD/RUN switch to load the temperature program. The first step # of the program will be displayed. You can either begin the temperature program at this first step or you can use the UP/DOWN arrows to increment to a subsequent step in the program.
8. Press the HOLD/RUN switch again to begin the temperature program
9. The lower display will indicate the program set temperature and the upper display will indicate the actual temperature of the heater blocks. Both displays should be within 1° of each other during the temperature program cycle.
10. The system will reset itself when the temperature program is done. To manually stop or interrupt the temperature program during a run, push the HOLD/RUN switch. This will return the controller to the manual (isothermal) mode of operation.

For further information refer to the Watlow Controller User's Manual.

### **Setting up the Temperature Program for the Watlow Controller**

It is often preferred to ramp the temperature of the Conditioning Oven heaters up to a predetermined rate of temperature rise to a set temperature, hold at that temperature for a predetermined time, and then allow the blocks to automatically cool down to a predetermined temperature. For example, desorption tubes packed with Tenax are routinely temperature programmed from ambient temperature up to 300° C at a rate of 4° C per minute while constantly purging with helium or other high purity carrier gas at flows not less than 20 ml per minute. The traps are held at the high temperature for four hours. After this time the power to the heater blocks are turned off, the desorption tubes are removed, allowed to cool, and are finally capped for storage. Traps prepared in this manner exhibit excellent adsorptive capacity and contain no organic background (bleed or artifact peaks) when analyzed by GC/MS. The temperature controller can be quickly and easily set up to conduct this automatic temperature ramp. Programs set up are stored

## 9 - Desorption Tube Conditioning System

in the controller's memory for future use. Programs are retained in memory, even when power is turned off to the Conditioning Oven. The controller can be programmed for multiple ramp profiles. You can continue entering program parameters until you run out of steps, there are a total of 24 steps available. The following program steps are used to create the program described above for the conditioning of the Tenax desorption tubes. Refer to the Watlow manual for detailed directions on how to enter these values into the Watlow temperature controller and for a detailed description of the Menu selection descriptions.

1. When the lower display reads set point, press MODE once until you see Prog (program parameter). Use the UP arrow key to select YES in the upper display. Press the MODE key once again.
2. The controller asks you for the STEP (Step Number). The upper display reads 1 (Step #1).
3. Press the MODE key to enter Step # 1 and you are then asked for StYP (step type). The default is END. Use the UP/DOWN arrow keys to select SoAh (soak) and then press the MODE key again to enter this value.
4. Use the below table to continue entering the parameters from left to right through the table. Remember that the MODE key is used to progress through the menu, and the UP/DOWN keys are used to select parameters and their values.
5. The program must end with the END statement
6. At the last step (Step # 5), when the program asks for rtn (Return), select YES. This will save the program and corrections in the controller memory, exit the program menu, and return to normal system operation.

<b>Step</b>	<b>StYP Step TYpe</b>	<b>SP Set Point</b>	<b>HOUr</b>	<b>Min</b>	<b>Sec</b>	<b>Ent1</b>	<b>Ent2</b>	<b>rATE</b>	<b>End rtn</b>	
1	SoAh	0	10	0	0	OFF	OFF	—	—	nO
2	StPt	300				On	OFF	4.0	—	nO
3	SoAh	4	0	0	0	On	OFF	—	—	nO
4	StPt	20				On	OFF	0.0	—	nO
5	END							—	OFF	YES

\*Ent1 and Ent2 values are not used on all models of the controllers.

Step 1 initializes the beginning set point to the current set point which has been manually entered and will hold it at this temperature for 10 minutes. This is designed to permit sufficient gas to flow through the desorption tube to remove all traces of oxygen from the Tenax contained therein before the heating cycle is begun.

## 9 - Desorption Tube Conditioning System

Step 2 sets a final temperature of 300° C which will be attained at a ramp rate of 4° per minute.

Step 3 holds the heater blocks at the high temperature (300° C) for a total of 4 hours.

Step 4 reinitializes the system to 20° C and begins the cooling cycle.

Step 5 ends the program.



Figure 9-7 – Funnel with Desorption Tube

### ***V. Standard Procedures for Preparing and Conditioning Desorption Tubes***

Upon installation, a carrier gas line from a high purity gas source such as nitrogen or helium is attached to a single 1/8" Swagelok fitting on the back of the Conditioning System. On top of the Conditioning System six quick disconnects are connected to 1/8" flexible Teflon lines to provide gas flow through the desorption tubes and needles during conditioning. The electrical connection is made with a 110 VAC plug which is grounded. Desorption tubes which have graphite seals and needles which have either graphite or graphitized Vespel seals screw into the Conditioning Oven handles.

Desorption Tubes are prepared in the following manner for use in the TD-5.

**A. Washing** - All desorption tubes should be thoroughly cleaned by a detergent and water rinsing followed by an acetone rinse in an ultrasonic bath and air dried. Appropriate ventilation, safety glasses and gloves should be used. Tubes are baked out in an oven at 100°C. Cleaning by additional solvents such as methanol may be required depending on the applications of the user. It is important to remove all solvent residues by thoroughly baking out the tubes.

## 9 - Desorption Tube Conditioning System

**B. Silylating** - Silylation with a suitable silylation reagent such as Dimethyldichlorosilane (DMDCS) under the trademark Silon™ T (Pierce Co.) is recommended depending on the nature of the components being analyzed and the requirements of the user. This is done under a hood with protective glasses and gloves. Tubes are capped on one end without a seal, placed in a beaker and filled with the reagent via a pipette for approximately one minute and then the reagent is discarded into a labeled hazardous waste container. This is preferred to dipping the entire desorption tube in the silylation reagent due to the reaction of the reagent with the outer metal covering resulting in the discoloration of the surface.

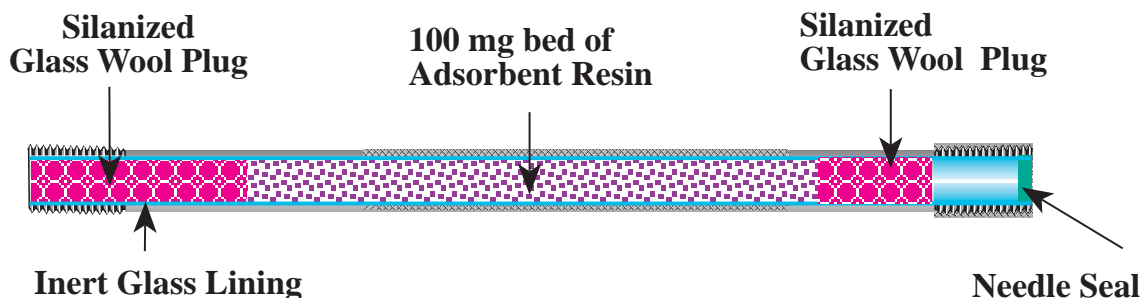

Figure 9-8 – Cross-section of packed GLT desorption tube.

**C. Rinsing** - This is followed by removing the caps and rinsing (2X) with methanol: methylene chloride (1:1) in a beaker in an ultrasonic bath for approximately 30 minutes each.

**D. Drying** - Tubes should be baked out in an oven at 100°C.

**E. Packing** - The sample tubes (3 & 4 mm I.D.) are next packed with a predetermined porous polymer resin such as 2, 6-diphenyl-p-phenyleneoxide sold under the trademark Tenax™ TA or the activated graphitized carbon sold under the trademark Carbotrap™ or combination thereof. Both of the above enumerated trapping agents have a high affinity for non-polar organic compounds and a very low affinity for water vapor and other low molecular weight polar compounds such as alcohols with less than three carbon atoms. Different trapping agents have affinities for different types of organic compounds and it is important to choose one which is known to have a high affinity for the analyte of interest. Tenax is ideal for aromatics, heterocyclics, aldehydes, ketones, alcohols etc. as long as the alkyl chain lengths are C-3 or longer. Carbotrap is good for the same type of compounds but also effectively traps aliphatic, olefinic and other types of paraffinic hydrocarbons which lack any other type of functionality. For these reasons we routinely make combination traps containing two or more trapping agents combined which then provides us with a broad spectrum general purpose trap. Two other trapping agents include Carbosieve S-III which is excellent for trapping small airborne molecules such as the C-2 hydrocarbons and Carbotrap C which is an ideal adsorbent for trapping a wide range of airborne organic compounds from C-4 to C-5 to polychlorinated biphenyls, polynuclear aromatics, and other large molecules. There are many other adsorbent

## 9 - Desorption Tube Conditioning System

materials which can function equally as well which are available from many manufacturers (Supelco, Alltech).

Three and 4mm I.D. desorption sample tubes are packed with approximately 40-250 mgs of adsorbent material using an S.I.S. funnel (Part# 781122) (Figure 9-7). The funnel fits snugly over the O.D. of the desorption tube providing easy packing of the adsorbent material. The amount of adsorbent used depends on the users requirements. The ends of the tubes are plugged with silanized glass wool approximately 1 cm on each end to hold the adsorbent in place (Figure 9-8).

**F. Conditioning** - In order to prepare the packed desorption tubes for the collection of samples, the adsorbent resins contained therein must be conditioned to remove all foreign materials including water vapor. This is done utilizing the Desorption Tube Conditioning Oven. The following procedure or a suitable version of this method should be used to condition the desorption tubes. The maximum temperature utilized will be determined by the properties of the adsorbent material used in the desorption tubes. Empty desorption tubes are conditioned in the same manner.

1. Attach desorption tubes with graphite seals with metal inserts to the Conditioning Oven handles.
2. Loosely attach caps with holes approximately 1.0 mm in diameter (Part#781007) on the bottom of the desorption tubes to prevent glass wool and adsorbent from blowing out the end of the desorption tube during conditioning under flow. Do NOT tighten, otherwise caps may seize after heating. Do not attach needles to desorption tubes for conditioning.
3. Turn on gas flow and adjust with microneedle valve to achieve flow of 20 ml/min through each desorption tube.
4. Insert desorption tube into heater block.
5. Set up temperature program for heater block. Refer to Watlow manual for details.
6. Flow gas through tubes for 3-10 minutes to remove all air/oxygen from inside tubes before heating.
7. Begin temperature program.
8. Flow condition for a minimum of 4 hours at maximum temperature.
9. When complete place tubes in the cooling rack on back of the cabinet.  
WARNING-HOT Do Not Touch. Use Teflon handles when removing tubes and needles from the heater block.
10. Allow to flow cool for 5-10 minutes. Do NOT flow longer than necessary when cooling or you will trap trace materials from the carrier gas.
11. Turn off heater. Allow to cool to less than 60°C and then turn off main power.
12. Condition solid caps with Teflon seals in GC oven at 200°C for 1-2 hours while desorption tube are conditioning. Remove and allow cooling.
13. Cap conditioned desorption tubes with stainless steel caps and seals.

**G. Storage** - The tubes are then immediately capped on both ends with stainless steel solid caps with Teflon seals that have also been conditioned. Tubes prepared in this

## 9 - Desorption Tube Conditioning System

manner exhibit excellent adsorptive capacity and contain no organic background when analyzed by GC/MS. Preconditioned tubes can be stored at room temperature for two to ten weeks.

**H. Needle Conditioning** - In the TD-5, the needle serves as the transfer line for sample introduction into the gas chromatograph from the glass-lined thermal desorption tube containing the samples being analyzed. This "short path" for sample transmission is a key advantage of the TD-5 minimizing sample decomposition, eliminating sample contamination (memory effects) of the transfer lines, and providing for maximum delivery of samples into the gas chromatograph (maximum sensitivity). It is therefore essential that the needles be baked out at 300°C for 15 minutes while purging with helium or another suitable gas at 20 ml/min in the Conditioning System prior to sample introduction into the GC. Repeat this after every sample. Attach the needles to the Conditioning Needle handles with the appropriate seals (graphite or graphitized Vespel). Cool before use.

**Note:** Empty desorption tubes for direct thermal desorption are conditioned in the same manner.

<b>Part No.</b>	<b>Description</b>
781051A	Desorption Tube Conditioning Oven (conditions 6 sample tubes simultaneously), 6 rotameters, programmable temperature controller, 6 desorption tube handles, 2 needle handles and seals
781013	Connection Handle for Desorption Tube
781014	Connection Handle for needle
781015	Graphite top seal with metal insert
781007	S.S. Cap with 0.040" hole for conditioning tube
781122	Funnel
781006	Cap, Solid
781004	Teflon Seals
782007	Fuse, 10A Slo-Blo

**Table 9-1 - Conditioning Oven and Replacement Parts**



## 9 - Desorption Tube Conditioning System

# 10. Sample Oven

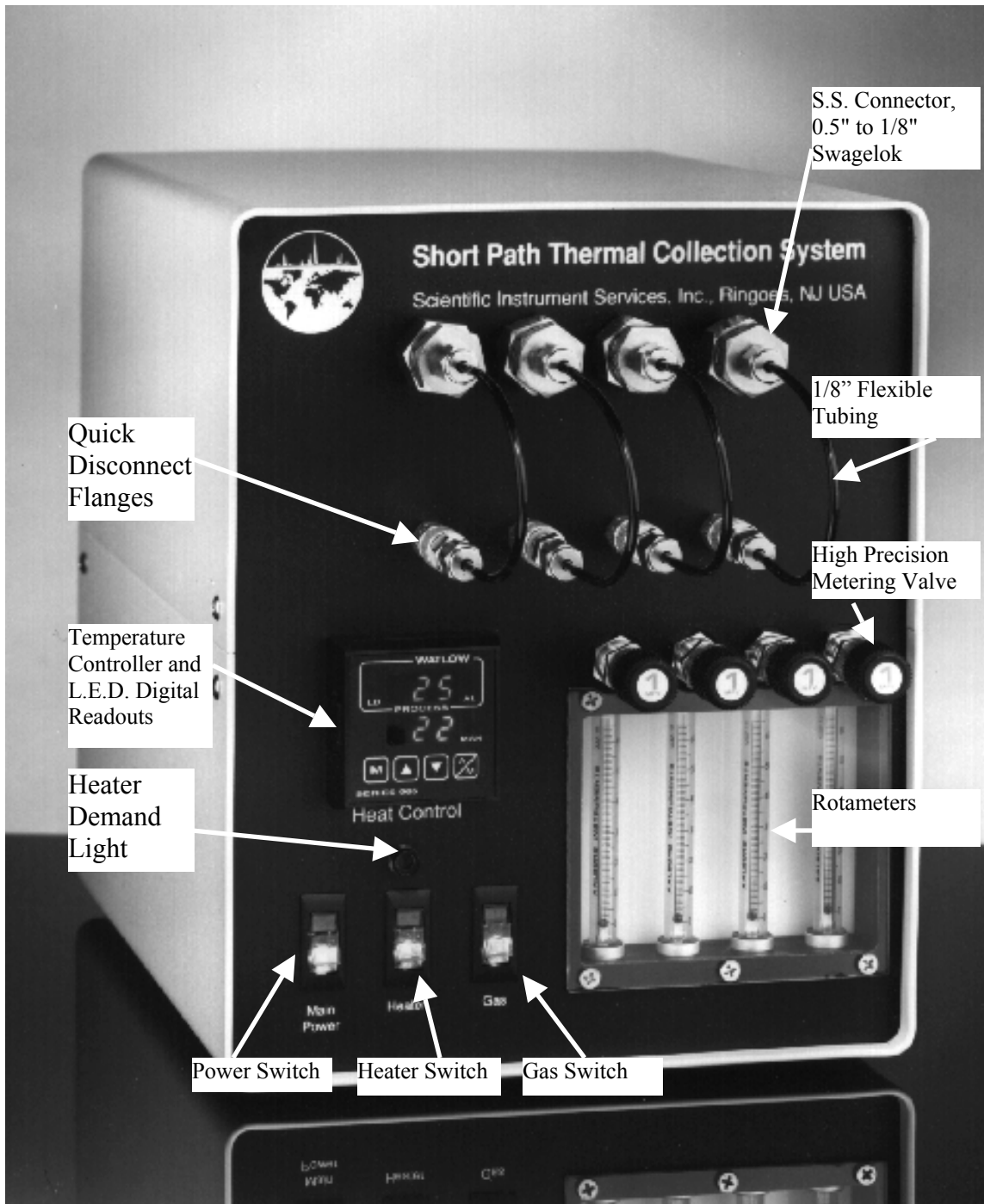

Figure 10-1 – Sample Collection Oven

## ***I. Introduction***

### **Theory of Operation**

The Sample Collection Oven (Figure 10-1) permits the collection of volatiles and semi-volatile compounds present in solid materials into desorption tubes packed with an adsorbent resin for subsequent analysis by desorption utilizing the TD-5. Volatile organics can be collected from sample sizes ranging from less than 0.5 grams up to 20.0 grams. The Sample Collection Oven consists of a sample tube oven with ports for four 0.5" or 0.25" diameter sample tubes. Up to four samples can be collected simultaneously with the system. A Watlow precision temperature controller provides accurate control of the temperature of the Sample Collection Oven up to 250° C. A digital readout indicates the actual oven temperature. The actual Sample Collection Oven consists of a large aluminum plate with holes drilled for the sample tubes and is heated by cartridge heaters. Heat transfer to the sample tubes occurs via direct thermal transfer from the aluminum block to the sample tubes. Temperatures can be maintained within 1% of the full scale reading. Four rotameters regulate the gas flow through each of the samples independently of one another.

## ***Safety - Warning Messages***

WARNING Do not heat samples above 250° C otherwise damage may occur to oven or internal circuitry.

WARNING Maximum gas pressure is 60 P.S.I.

WARNING Do NOT use Hydrogen Gas in the Sample Collection Oven. Use only He or N<sub>2</sub>.

WARNING Make sure that only fuses with the required rating and of the specified type are used for replacement. The use of incorrect or makeshift fuses or the short-circuiting of fuse holders creates a shock hazard for the operator and can damage the instrument.

WARNING Do NOT increase temperature range of heat overload circuit.

WARNING Do NOT leave Sample Collection Oven heaters in the heated ON position unattended overnight. The Sample Collection Oven heaters rapidly heat and cool to their final operating temperatures and therefore, in order to prolong their life and avoid premature failure of the system they should be turned off when not actively being utilized.

WARNING Use grounded outlet only. Connecting the Sample Collection Oven to a power source which is not equipped with a protective earth ground contact creates a shock hazard for the operator and can damage the instrument.

WARNING The Sample Oven should be used in a laboratory hood.

WARNING Do not expose persons to the direct line exposure of the ends of the sample tubes. Fittings can slip off under pressure and cause injury if the user is not protected.

WARNING Safety glasses must be worn when using the Sample Oven. High gas pressures are present and glass sample tubes are used which may present a hazard.

## ***Specifications***

### **Electrical Specifications**

Power Requirements

Voltage - 110 VAC

Current - 10 amps maximum

Electrical Cord - 110 v/grounded outlet

### **Temperature Controller**

Heater Circuit - Accuracy - +/- .1% of full scale- Range - up to 250° C

Heater Output - 115 volt, 1200 watts

Sensor Input - Platinum Resistance Thermometer

Heater Cartridges - 4 each - 115 v, 300 watts  
Digital Readout for set & actual temperatures 3 or 4 digit  
Temperature Range - Room Temperature to 250° C

**Gas / Pressure Specification**

Type - Nitrogen or Helium (high purity)  
Maximum pressure - 60 P.S.I.  
Flow - maximum 50 ml / min per tube  
- Maximum total 200 ml / min  
Quick disconnects - automatically turn off gas

**Weight and Dimensions**

Weight - 18 pounds  
Size - 9" wide x 12" deep x 11" high

***Warranty***

The Sample Collection Oven is warranted against defects in material or workmanship for a period of 90 days commencing from the date of shipment from the warehouse of Scientific Instrument Services in Ringoes, N.J. hereafter referred to as the company. The company's liability on the Sample Collection Oven and accessories is limited to the cost of correcting the defect in the product. In no case shall the company be liable for consequential or special damages. The system should not be run unattended overnight. The company will not correct defects caused by buyers negligence. The company does not guarantee or warrant the product for any particular purpose. The companies warranty shall end 90 days after shipment.

**Extended Warranty**

An extended one year warranty for parts and labor is available if purchased within 30 days of shipment of the unit. The one year extended warranty will cover parts and labor to repair the Sample Collection Oven within the facilities of Scientific Instrument Services. Service on customers' facilities is not available.

**Service and Repair**

The Collection Oven should be serviced only by qualified S.I.S. staff. Any shipment to be serviced under warranty or otherwise should be sent to the repair facilities of Scientific Instrument Services in Ringoes, N.J. No on - site service is available. A Return Authorization Number (RA #) must be obtained from the offices of Scientific Instrument Services before any equipment is returned.

Scientific Instrument Services, Inc.  
1027 Old York Road  
Ringoes, NJ 08551  
Attn: Repair Department

RA # \_\_\_\_\_  
Phone: (908) 788-5550

## II. System Description

### Front Panel Description (Figure 10-1)

Three on/off switches are present on the front panel including a main power switch, a heater switch and a gas switch. The main power switch controls the power to the entire Collection Oven, to the temperature controller, and other switches. The heater switch turns on the power to the heater cartridges in the heater block and begins its heating cycle. This switch should be turned off at night or when the system is not in use. The carrier gas switch turns on the carrier gas to permit its flow through the samples. An L.E.D. digital readout displays the set temperature and the actual temperature of the system. A heater demand light indicates the actual heating demand of the heater blocks. If the demand light is bright red the heater is on; heater is off when there is no light. If the demand light is dim red, the heater is unplugged or an open circuit exists.

The self contained system includes four adjustable bubble rotameters with flow ranges of 0 to 50 ml/min, one for each of the sample tubes. The recommended flow rate is 20 ml/min. Flow meter calibration data for air and helium are listed in Table 1. Each of the flows through the tubes can be independently controlled or flow turned off to that port via a high precision metering valve. A single electrically operated solenoid valve turns the gas flow off or on to all ports via the gas switch on the front panel. Four quick disconnect fittings connect to a 1/8" flexible transfer line to provide gas flow through each of the sample tubes during sampling. The quick disconnects turn the flow off to individual gas flow lines when disconnected.

TABLE 1  
Flow meter Calibration Data  
Scale Readings at Center of Float

Scale Readings	Flow ml/min (Helium)	Flow ml/min (Air)
65	44	48.7
60	39	43.3
55	33	37.6
50	28	31.4
45	23	26.5
40	20	22.4
35	17	19.1
30	15	16.0
25	12	12.7
15	6	6.6
10	4	4.7
5	3	3.3

### B. Rear Panel Description (Figure 10-2)

Electrical power is provided from a standard 110 volt, 10 amp grounded outlet. A single 1/8" Swagelok fitting on the back of the Sample Collection Oven provides for the attachment of the carrier gas from its source. An external high temperature reset switch is located in the rear of the oven so that if temperatures exceed 250° C on the heater block, the external reset will open and heat to the block will stop. This switch can be reset by simply pushing in this red button once the block has cooled. Two Slo Blo fuses are mounted in the rear of the Collection Oven to handle the initial surges of the Main Power and Heater switches when they are turned on.

In addition, a three inch fan enclosed on the back side of the Collection Oven provides a steady flow of air through the system to maintain the temperature of the temperature controller, rotameters, and other components inside the system at an acceptable level and to provide for cooling of the heater block once the heater circuitry is turned off.

### ***Electrical and Gas Flow Circuit***

The Sample Collection Oven schematic (Figure 10-3) pictorially represents the overall operation of the system including the gas flow and heater circuits. A 110 volt outlet is required, and 10 amps provides the total electric power required for system operation.

The self contained system includes four adjustable bubble rotameters with flow ranges of 0 to 50 ml/min, one for each of the sample tubes. Each of the flows through the tubes can be independently controlled via a microneedle valve and the flow turned off to that port if no flow is required. A single electrically operated solenoid valve (v) turns the gas flow off or on to all ports via the gas switch on the front panel (Figure 10-3).

On the front of the Sample Collection Oven four quick disconnect fittings connect to a 1/8" flexible transfer line to provide gas flow through each of the sample tubes during sampling. When a quick disconnect is removed the gas flow is automatically closed to that port. By providing gas flow from a carrier gas such as high purity nitrogen or helium through the sample tubes while sampling, it can be assured that no oxygen enters the desorption tube which could destroy the adsorbent material. A single 1/8" Swagelok fitting on the back of the Collection Oven is provided for the attachment of the carrier gas from the source (Figure 10-2).



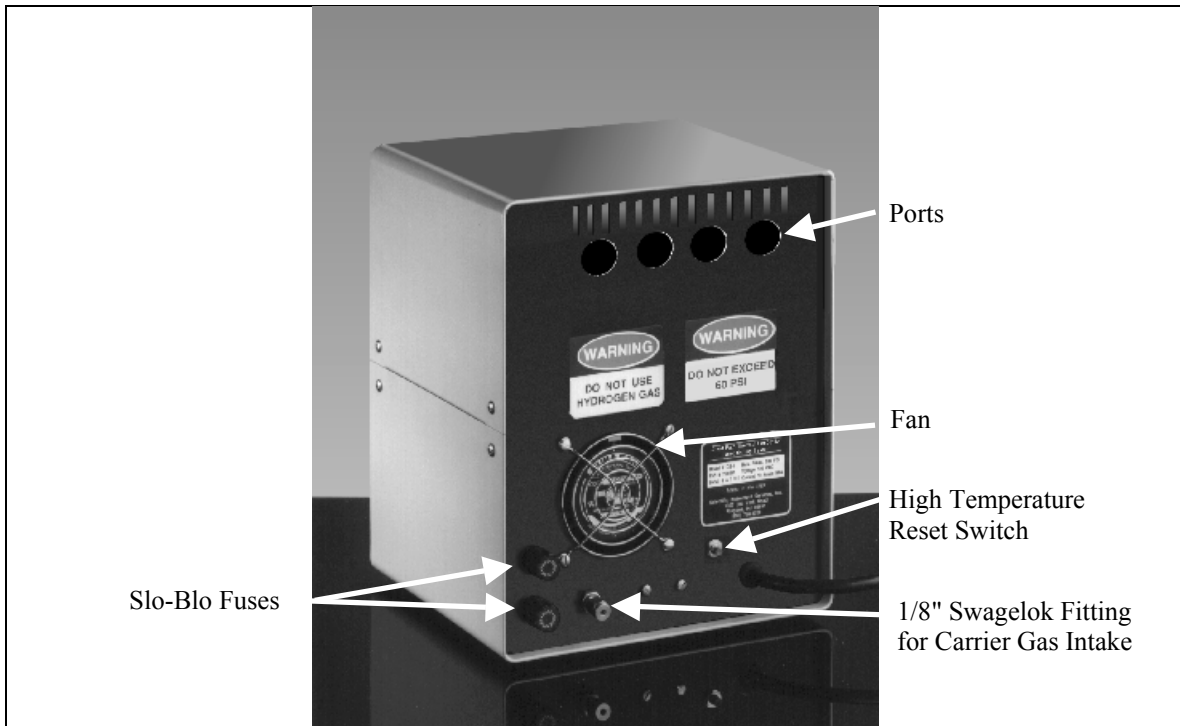

**Figure 10-2 - Sample Oven - Back View**

### ***Heater Circuit***

The Sample Collection Oven includes a heater block with ports for four 0.5" diameter sample tubes. Up to four samples can be collected simultaneously at temperatures up to 250° C with the system. A Watlow Microprocessor Based Auto-tuning temperature controller permits the setting of the temperature at which the samples are to be collected. A platinum resistance thermometer (PRT) in the heater block provides for accurate temperature readout and also provides the feedback to the temperature controller to maintain the heater block temperatures. Accuracy of the programming temperatures is +/- .1% of the full scale reading. An L.E.D. digital readout displays the set temperature and the actual temperature of the system.

Four 3/8" diameter 300 watt heater cartridges heat the aluminum heater block. The heater cartridges are wired in parallel and are protected by their own 10 amp fuse. The heater indicator light displays the current demand for the heater cartridges. When off, the heaters are not receiving any power and therefore are not heating. When brightly lit the heater cartridges are in the heating cycle. If dimly lit, the heater is unplugged or an open circuit exists.



## Heater Protection Circuitry

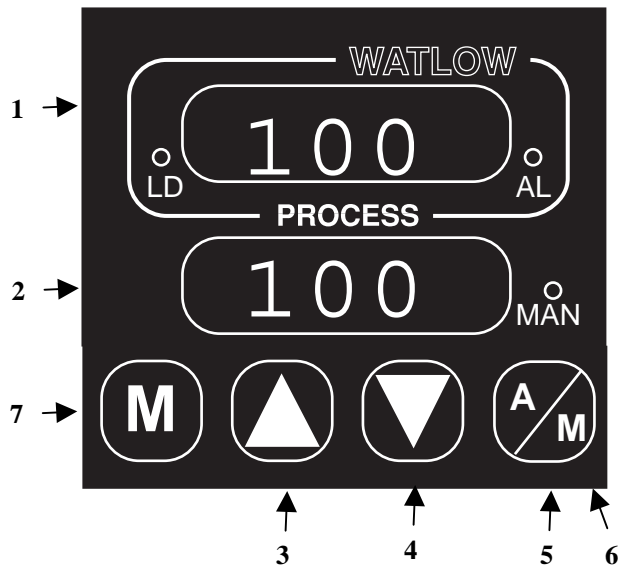

**Figure 10-4 – Watlow Temperature Controller keys and display**

A heat overload thermostat (internal reset switch) is located inside the case of the Sample Collection Oven to prevent temperatures from exceeding 60° C inside the case, thereby providing a protective circuitry for the system. If the Oven case should exceed 60° C due to a circuit failure (such as failure of the cooling fan to operate), this overload sensor will open the circuit that provides power to the heater cartridges. This overheat sensor can only be reset by allowing the system to cool, opening the Oven case, and manually resetting the internal overload reset switch. If the heat overload thermostat should open when operating the system, the entire Sampling Oven should be returned to the factory for service. Service should only be performed by qualified electrical technicians knowledgeable of the system electrical circuits. In addition, a high temperature limit control board with an external high temperature reset switch (Figure 10-2 - Hi temp reset) prevents heater block temperatures from exceeding 250° C. If block temperatures exceed 250° C, the external reset will open and heat to the block will be terminated until the block cools and the external reset switch is reset (Figure 10-2). Note: Do not exceed 250° C for the heater block.

## Watlow Temperature Controller

### Description of the Keys and Display

**1. Upper Display (Actual heater block temperature)** - The red, 0.3" (8 mm) high, seven segment, three digit LED display, indicates the heater block temperature, the operating parameter values, or an open sensor. When powering up, the Process display will be blank for 5 seconds.

**2. Lower Display (SET temperature)** - The red 0.3" (8 mm) high, seven segment, three digit LED display, indicates the set point, output value, prompts for data in the upper display, or error and alarm codes.

**3. UP Key** - Increases the value of the temperature set point. A light touch increases the value by one. Holding the key down increases the value at a rapid rate. New data is self entering in 5 seconds.

**4. DOWN Key** - Decreases the value of the temperature set point (lower display). A light touch decreases the value by one. Holding the key down decreases the displayed value at a rapid rate. New data is self entering in 5 seconds.

**5. AUTO/MAN Key** - This key is inoperable as set by the factory. The System always runs in the automatic mode. Refer to the Watlow 965 controller manual for more information.

**6. Mode key** - Allows the user to step through the operation menu. This key is inoperable as set by the factory. For more information see the Watlow 965 controller manual.

Note: The following is a description of the factory preset values. This is given only for reference in case of a problem. The values should never be changed. Refer to the Watlow 965 manual for more information.

## Temperature Controller System SETUP

The purpose of the SETUP menu is to define the various operating parameters and condition of the temperature controller. These user selectable parameters include the conditions of controller operation, the calibration parameters, rate of heating, sensor input type, temperature scale (°C or °F), display decimal point location, and temperature range. The Watlow temperature controller has already been preset to the correct operating parameters at the factory and the user should not normally have needed to alter these factory settings. The SETUP Menu is entered by pressing both the UP and DOWN arrow keys simultaneously for 3 seconds. The values presently in the controller on the Sampling Oven have been factory selected for the correct operation of the Sampling Oven. It is NOT recommended that they be changed. For a detailed description of these parameters and the selections available refer to the Watlow Users Manual.

Setup Menu		Operation Menu	
LOC	3	Pb1	13
In	rtd	rE1	0.06
C_F	C	rA1	1.25
rL	0	Ct1	5
rH	250	CAL	0
Ot1	ht	AUt	0
HYS	2		
All	no		
rtd	din		

**Figure 10-5 - The factory preset values are listed above.**

### ***Operation of the Sample Oven System***

The Sample Collection Oven permits the analysis of trace components in larger sample sizes than could be analyzed by direct thermal desorption in the TD-5 Short Path Thermal Desorption System. Samples to be analyzed are placed inside glass tubes and held in place by glass wool plugs. The system is designed to sample from 0.5" diameter tubes, and also from 0.25" diameter tubes with optional adaptors. Sample tubes are each 14" long. Samples up to 20 grams can be sampled in the 0.5" diameter tubes. When ready for sample collecting, the long tube containing the sample is placed in the Sample Collection Oven, fitted at one end with a supply of carrier gas to flush out the residues, and fitted at the opposite end with an adaptor fitting and a preconditioned desorption tube with adsorbent resin (Figure 10-6). The Oven is set for the predetermined temperature and the desired components are collected onto the desorption tubes. Oven temperatures can range from room temperature up to 250°C. The temperature used, as well as the time of sampling, depends on the nature of the samples being analyzed and the requirements of the analyst. By providing gas flow from a carrier gas such as Nitrogen or Helium through the heated sample tubes while sampling, the volatile and semi-volatile organics will be purged from the sample and will be trapped by the adsorbent in the desorption tube.

This technique also permits the analysis of volatiles from organic samples with high moisture content. A desorption tube adaptor fitting with a dry purge inlet can be used to reduce the water vapor condensation on the adsorbent trap. This problem can be especially troublesome when isolating volatiles from high moisture content samples at high temperatures. Although the adsorbent traps packed with Tenax have a low affinity for water it is inevitable that some condensation will occur when the heated sparge gas contacts the cool desorption tube adaptor fitting as the gas exits the apparatus. When moisture condenses on the adsorbent it can block the pores of the resin matrix and thereby drastically reduce the diffusion of volatile organics into the trapping agents. This will result in reduced trapping efficiency. With an additional dry purge, the gas is kept in the vapor phase and passes through the adsorbent resin without condensing onto the adsorbent.

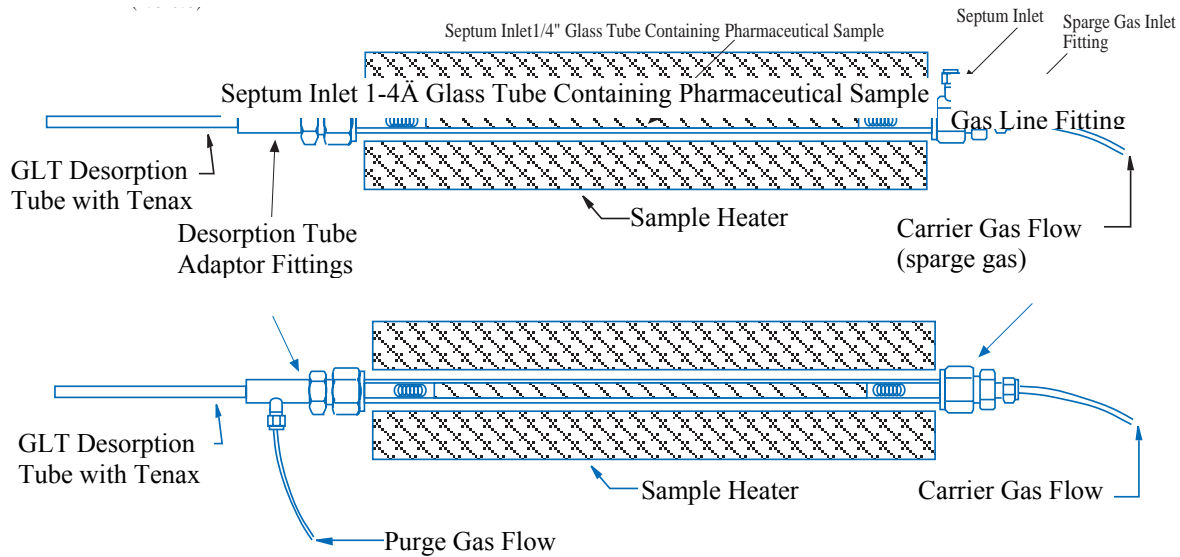

**Figure 10-6 – Cross section of Sample Collection Oven for the collection of thermally sparged samples.**

The following procedure or a suitable version of this method should be used to sample solid samples.

### **I. Turn on Procedure**

1. Turn on main power. Note: The Sample Oven should be used in a laboratory hood. See page 11-2 for caution notes. The Sample Oven operates under pressure with glass tubes. Extreme caution must be exercised when using. Eye protection must be worn when using the Sample Oven. Do not expose face to direct line exposure of sample tubes.
2. Use the UP/DOWN arrow keys to select the desired temperature of the heater block (SET temperature is displayed on the lower LED display of the Watlow controller).
3. Turn on the heater switch. Within 5 minutes the heater block temperature (Upper display) should reach the same value as the SET temperature (Lower display).
4. Safety glasses must be worn when using the Sample Oven. High gas pressures are present and glass sample tubes are used which may present a hazard.

### **II. Cleaning & Conditioning Sample Tubes**

1. Wash sample tubes in detergent and water in appropriate container for 15 minutes, then rinse in a solvent such as acetone for 15 minutes and let air dry.
2. Condition sample glass tubes with glass wool plugs 50°C above sample temperature to be used (maximum temperature - 250°C) for 15 minutes in the Sample Oven under low

gas flow (10 ml/min) prior to collecting sample, then remove the tubes from the Sample Oven and allow cooling to room temperature.

3. Glass wool can be conditioned separately and stored until ready for use.

### **III. Sampling**

1. Insert preconditioned glass wool plug in one end of sample tube, then place sample to be analyzed inside sample tube and hold in place with additional glass wool.

2. Place preconditioned sample tube containing sample into Sample Collection Oven.

3. On front of Collection Oven connect quick disconnect fitting to 1/8" flexible transfer line via S.S. Connector, 0.5" to 1/8" Swagelok to provide gas flow through sample tube (Figure 10-6 and Figure 10-7).

4. At the opposite end of the sample tube connect a preconditioned desorption tube with adsorbent resin to the sample tube via a S.S. Connector, 0.5" Swagelok to desorption tube (Figure 10-6 and Figure 10-7). Refer to Conditioning Oven Manual for conditioning desorption tubes.

5. Turn on carrier gas and begin collecting VOCs.

6. Do not expose persons to the direct line exposure of the ends of the sample tubes. Fittings can slip off under pressure and cause injury if the user is not protected.

7. When VOCs have been collected removed desorption tube and cap until ready for analysis.

Part No.	Description
782050	Sample Collection Oven for 4 samples with 4 rotameters 4-0.5" ports, 4-0.5" glass sample tubes with fittings
782061	Sample Tube, Glass, 0.5" O.D. x .36" I.D. x 14" long
782062	Sample Tube, Glass, 0.25" O.D. x .15" I.D. x 14" long
782063	Sample Tube, Stainless Steel, 0.5" O.D. x .36" I.D. x 14" long
782064	Sample Tube, Stainless Steel, 0.25" O.D. x .15" I.D. x 14" long
782065	Reducing Adaptor Vespel, 0.5" to 0.25" sample tube
782066	Reducing Adaptor Teflon, 0.5" to 0.25" sample tube
782071	S.S. Connector, 0.5" to 1/8" Swagelok
782072	S.S. Connector, 0.5" Swagelok to Desorption Tube
782073	S.S. Connector, 0.25" to 1/8" Swagelok
782074	S.S. Connector, 0.25" Swagelok to Desorption Tube
782081	0.5" Teflon seal
782082	0.25" Teflon seal
782075	S.S. Connector, 0.5" to Desorption Tube with 1/16" purge gas inlet
782076	S.S. Connector, 0.25" to Desorption Tube with 1/16" purge gas inlet

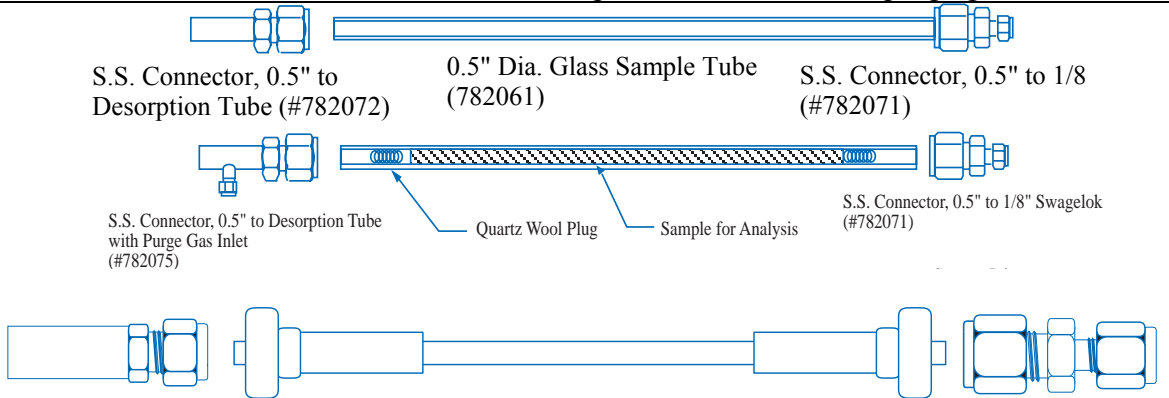

Figure 10-7 – Sample tube with connectors

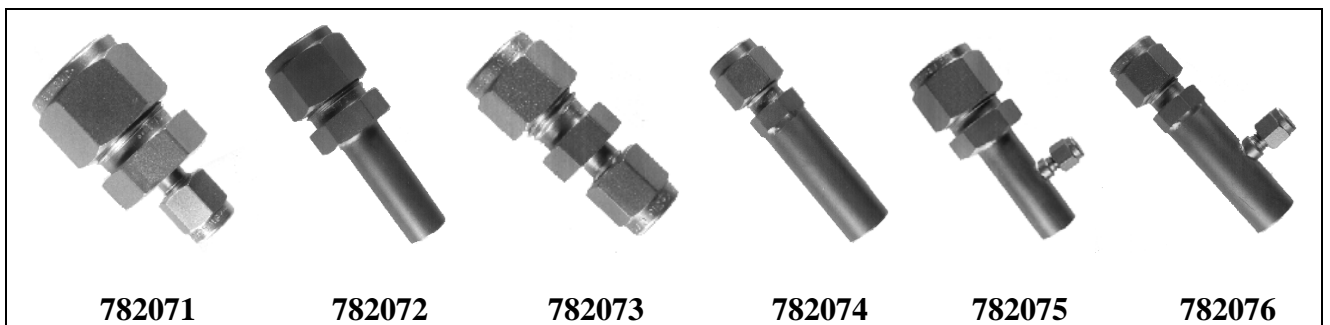

Figure 10-8 - Fittings & Adaptors for Sample Collection Oven



Part No.	Description
782050	Sample Collection Oven for 4 samples with 4 rotameters 4-0.5" ports, 4-0.5" glass sample tubes with fittings
782061	Sample Tube, Glass, 0.5" O.D. x .36" I.D. x 14" long
782062	Sample Tube, Glass, 0.25" O.D. x .15" I.D. x 14" long
782063	Sample Tube, Stainless Steel, 0.5" O.D. x .36" I.D. x 14" long
782064	Sample Tube, Stainless Steel, 0.25" O.D. x .15" I.D. x 14" long
782065	Reducing Adaptor Vespel, 0.5" to 0.25" sample tube
782066	Reducing Adaptor Teflon, 0.5" to 0.25" sample tube
782071	S.S. Connector, 0.5" to 1/8" Swagelok
782072	S.S. Connector, 0.5" Swagelok to Desorption Tube
782073	S.S. Connector, 0.25" to 1/8" Swagelok
782074	S.S. Connector, 0.25" Swagelok to Desorption Tube
782081	0.5" Teflon seal
782082	0.25" Teflon seal
782075	S.S. Connector, 0.5" to Desorption Tube with 1/16" purge gas inlet
782076	S.S. Connector, 0.25" to Desorption Tube with 1/16" purge gas inlet

**Figure 10-9 - Sample Collection Oven System and Accessories**

# Appendix A – TD Specifications

<p>Power Requirements 115 Volt +/- 10% AC 10 amp max</p> <p>Gas Requirements Carrier Gas (He or Nitrogen) 40-60 psi</p> <p>Compressed Air Laboratory supply or cylinder 40 psi Alternative, tee into carrier gas supply</p> <p>Desorption Heater Blocks Heater Output - 115 volt, 600 watt Input - Platinum Resistance Thermometer (PRT) Temperature Range 20 to 400°C Temp. Ramp: 0°to 100°/min.</p> <p>Temperature Control of GC Cryo-Trap Accessory Heating - Maximum Temperature 400°C Cooling - Minimum Temperature CO2 -70°C LN2 -180°C</p>	<p>Microprocessor Control RS232 Interface to PC Operating Voltage: 24 Volt DC Flash + Battery Backup</p> <p>Weight &amp; Dimensions Desorption Unit Weight - 17 lbs Size – 120 cm Wide, 540 cm High, 170 cm Deep (~250 cm with cable)</p> <p>Electronics Console Weight - 6 lbs Size: 310 cm Wide, 110 cm High, 210 cm Depth (~300 cm with cables)</p>
---	--